



CONTENTS

Aircraft Introduction	2
Aircraft Cockpits	6
Heads-Up Display Modes	30
Sensors	68
Radar Warning Receivers	76
Air-to-Air Missiles	82
Air-to-Ground Weapons	97
Ground School	108
Primary Flight School	112
Air Combat Basics	115
Weapon Usage	129
Warranty	134
Technical Support	135

2 Aircraft Introduction

Aircraft Introduction 3

AIRCRAFT INTRODUCTION

The old adage, "Use the right tool for the job," applies to air combat as much as carpentry. Aircraft missions, such as air superiority, close air support, deep strike, etc., generally have conflicting requirements. Heavy armor that protects a pilot while engaging an enemy AAA site is a serious disadvantage in a dogfight. Success in the air requires a thorough understanding of each aircraft's strengths and weaknesses. The following section identifies each aircraft flyable by the player and summarizes its combat role.

1.1 F-15C "Eagle"

The F-15C "Eagle" has often been labeled the greatest fighter aircraft in the world. Designed to counter the exaggerated capabilities of the Soviet MiG-25 "Foxbat," the F-15 has been the backbone of U.S. air defense for three decades. The F-15C, equipped with improved avionics and weapons over the original F-15A, has scored over 100 air-to-air victories in the service of Israel, Saudi Arabia, and the U.S. without suffering any losses.

The F-15C rules the Beyond Visual Range arena (BVR). No slouch in a dogfight, the F-15C excels at finding targets, positively identifying them as hostile, and engaging them with AIM-120 AMRAAM and AIM-7M missiles before the enemy can respond.

The Eagle is somewhat restricted in the close-in dogfight. The AIM-9 Sidewinder, a reliable weapon that has soldiered on since the 1960's, does not have the high off-boresight capability of recent Russian heat-seeking missiles. Eagle drivers should generally favor the higher-speed "energy fight" in favor of the low-speed turning duel, especially against nimble adversaries.

Length: 63' 9"

Height: 18' 8"

Wingspan: 42' 10"

Speed: Mach 2.5+ at sea level

Ceiling: 65,000'

Max. Takeoff Weight: 68,000 lbs

1.2 A-10A "Thunderbolt II"

Very few address this aircraft by its given name of "Thunderbolt II." Instead, its unusual appearance earned it the moniker "Warthog," and often simply "the Hog." Designed as a Close Air Support (CAS) platform to counter the massive quantities of Soviet armor during the Cold War, the Hog is heavily armored and carries an impressive weapon load, including a deadly 30mm anti-armor cannon. Efforts to retire the A-10 from active duty began gaining momentum, but fell by the wayside after the aircraft's stellar performance during the 1991 Gulf War and the 2003 Operation Iraqi Freedom.

The A-10 was intended to fly low, using the terrain to mask its presence from enemy Surface-to-Air Missiles (SAMs). Low flying, however, places the aircraft in the heart of the Anti-Aircraft Artillery (AAA) engagement zone. Therefore, the aircraft is heavily armored, including a "titanium bathtub" which surrounds the pilot. When the threat of SAMs has been reduced, the A-10 generally flies

missions at medium altitudes, placing it safely out of the reach of AAA guns.

The sub-sonic A-10 can carry AIM-9 Sidewinders for self-defense, but should avoid dogfighting. It carries an impressive air-to-ground weapon load, but lacks the power for a sustained fight against a dedicated air-to-air platform. When confronted by an enemy fighter, the Hog pilot should use the A-10's impressive turn rate capability to point the nose (and the dreaded 30mm cannon) at the attacker. When the attacker overshoots, unload and extend until the attacker makes another pass, and then use another maximum-rate turn to point the nose back at the adversary.

Length: 53' 4"

Height: 14' 8"

Wingspan: 57' 6"

Speed: Mach 0.56

Ceiling: 45,000'

Max. Takeoff Weight: 51,000 lbs

1.3 Su-25 "Frogfoot"

The Su-25 Frogfoot bears little resemblance to the U.S. A-10, but was designed for a very similar Close Air Support (CAS) ground-attack mission. The Su-25 was built to operate near the battlefield from rough, "unimproved" airstrips, and can carry a kit with tools, spare parts, auxiliary power supply, a pump for manual refueling, and other "self-deployment" supplies. It carries a wide variety of weapons for missions, including anti-radar, runway denial, and tank killing.

The fortified cockpit and armored canopy helps protect the pilot from AAA and small-arms fire while engaging targets at low altitude. Flying low, the Su-25 hunts down mobile targets, pops up, delivers its weapons, and dives back behind the terrain. The Frogfoot may arguably be the most powerful ground-attack aircraft in Eastern inventories.

The Su-25 is not intended for dogfighting, though. Its primary defense against patrolling flights is simple avoidance. When engaged, the Su-25 should operate at extremely low altitude, which hampers enemy fighters' ability to dive toward it. Using available terrain, the pilot should turn to face oncoming threats.

Length: 50' 11"

Height: 15' 9"

Wingspan: 47' 11"

Speed: Mach 0.8 at sea level

Ceiling: 22,965'

Max. Takeoff Weight: 38,800 lbs

1.4 Su-27 "Flanker B"

The Su-27 Flanker and its descendants are some of the most impressive and capable fighter aircraft in the world, designed to beat the vaunted F-15. Born in the waning years of the Cold War, the Flanker did not have an easy life. The initial design suffered serious problems. Then, the breakup of the Soviet Union hindered its deployment, denying it the opportunity to prove itself as the world's greatest aircraft.

4 Aircraft Introduction

The Su-27 is tailored for air-to-air combat, not air-to-ground. Armed with the R-27 (AA-10) Alamo missiles, the Flanker has an impressive BVR capability. Meanwhile, the helmet-mounted sight and the high off-boresight R-73 (AA-11) Archer heat-seeking missile, coupled with the Su-27's high thrust and sustained turn capability give the aircraft a powerful edge in a knife fight. High-AOA maneuvering helps the pilot point his weapons at the enemy. Finally, its large fuel capacity keeps it in the fight well after most Western aircraft are running on fumes. It carries as many as ten air-to-air missiles, giving it an impressive "punch."

Detractors criticize the Su-27's avionics and cockpit layout, citing limited ability to track/engage multiple targets, high reliance on GCI control, and high pilot workload, but its passive Electro-Optical System (EOS) lets it find and engage targets without any radar signals (which can warn the target). Debate continues on whether high-AOA maneuvers (such as tail slides and the famed "Cobra") are useful combat tactics or merely impressive air-show routines.

Length: 71' 11"

Height: 19' 5"

Wingspan: 48' 2"

Speed: Mach 2.35 at sea level

Ceiling: 59,055'

Max. Takeoff Weight: 72,750 lbs

1.5 Su-33 "Flanker D"

Originally named the Su-27K, this descendant of the Su-27 was specifically designed to operate from Soviet versions of super aircraft carriers. Equipped with canards for improved takeoff and landing performance, the first Su-27K made its maiden flight in 1985. The tail cone was shortened to reduce the risk of tail strike during high-AOA carrier landings, but also reduced the space available for defensive countermeasures (including chaff and flare dispensers). Whereas the Su-27 was tailored as an air-to-air interceptor, the Su-33 is a multi-role aircraft (a necessity of carrier-based aviation operating far from home bases). The Su-33 retains, to a large extent, the avionics and cockpit of the basic Su-27.

Length: 69' 6"

Height: 19' 4"

Wingspan: 48' 2"

Speed: Mach 1.14+ at sea level

Ceiling: 55,250'

Max. Takeoff Weight: 66,000 lbs

1.6 MiG-29A "Fulcrum A" and MiG-29S "Fulcrum C"

Western observers often conclude, inaccurately, that the Su-27 and MiG-29 were born of a single design program, which copied the U.S. Navy's F/A-18, no less. Indeed, the Su-27 and MiG-29 look quite similar, and some observers cannot readily tell the two aircraft apart, despite the MiG-29 being substantially shorter than the Su-27. Both the Su-27 and MiG-29 design teams reportedly worked with common research data and drew common design conclusions. The MiG-29 was much more widely exported than the Su-27, serving in many Warsaw Pact air

Aircraft Introduction 5

forces, several of which have since joined NATO (bringing their Soviet-made MiG-29s with them).

The MiG-29 originally shared most of its avionics suite with the Su-27 (including the radar, the Electro-Optical System (EOS), and the helmet-mounted sight), but was designed as a short-range fighter, not an interceptor. The EOS lets the Fulcrum search for, track, and engage targets without emitting tell-tale radar signals. Being smaller, it doesn't carry as many missiles as the Su-27, but its high-AOA maneuverability, coupled with the R-73 (AA-11) Archer high off-boresight, heat-seeking missile, and helmet-mounted sight makes the MiG-29 a deadly dogfighter. The slow-speed turning fight is the MiG-29's preferred arena where it can use its high-AOA capability to point its weapons at a floundering target. The newer MiG-29C includes the medium-range R-77 (AA-12) Adder missile and an internal radar jamming system.

As with the Su-27, critics cited weak avionics and poor cockpit design as weaknesses of the MiG-29A. The later MiG-29S (Fulcrum C), though, incorporated numerous improvements, including better defensive countermeasures and increased fuel capacity. The MiG-29 reportedly requires a significant amount of maintenance, especially the engines. German MiG-29As (inherited from the East when Germany was re-unified) have had their engine performance "tuned down" somewhat to preserve engine lifespan. Obtaining spare parts continues to be a concern for former Warsaw Pact nations.

Russian forces in LOMAC employ the MiG-29A and MiG-29S, while German forces in NATO operate only the MiG-29A.

Length: 56' 10"

Height: 15' 6"

Wingspan: 37' 3"

Speed: Mach 2.3 at sea level

Ceiling: 55,775'

Max. Takeoff Weight: 40,785 lbs

6 Aircraft Cockpits

Aircraft Cockpits 7

AIRCRAFT COCKPITS

Each aircraft's cockpit is tailored for the role it performs. Although all cockpits share certain instruments, such as an airspeed indicator, an attitude indicator, engine indicators, etc., cockpit design philosophies have changed dramatically over the years. Furthermore, Eastern and Western aircraft designers often take different approaches to solving common problems. As a result, cockpit layout varies greatly from aircraft to aircraft.

In this chapter, we'll examine each aircraft's cockpit and instrumentation. You'll need to familiarize yourself with the cockpit layout for each aircraft type you intend to fly.

2.1 F-15C Eagle Cockpit

Although the F-15C Eagle retains a nominal air-to-ground capability, it is strictly an air-to-air superiority fighter today. Consequently, its cockpit is tailored around the radar display and threat warning display, which are situated just below the HUD. The lower section of the instrument panel focuses on aircraft attitude, engines, and storage management.

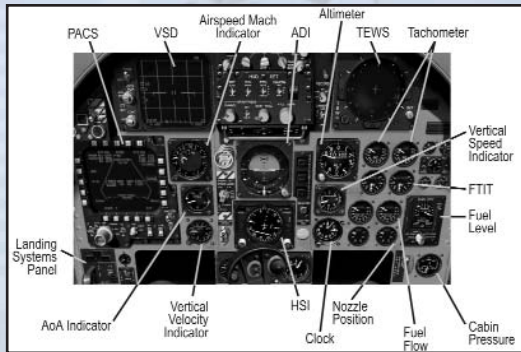

The F-15C Cockpit

2.101 Vertical Situation Display (VSD)



The VSD

The Vertical Situation Display (VSD), otherwise known as the "radar display," dominates the instrument panel's upper-left corner. The VSD shows a top-down view of the airspace ahead of the aircraft, highlighting target aircraft detected by the radar. Full details of radar operation and VSD symbology appear in the "Sensors" chapter.

2.102 Tactical Electronic Warfare System (TEWS)

The Tactical Electronic Warfare System (TEWS), located in the upper right of the instrument panel, detects radar emissions (from other aircraft, surface-to-air missile launchers, etc.). It



The TEWS

categorizes the information it detects and displays clues about the direction and type of emitter. Full usage and symbology details appear in the "Radar Warning Receivers" chapter.

2.103 Programmable Armament Control System (PACS)

The Programmable Armament Control System (PACS), located in the lower left of the instrument panel, is a multipurpose display that provides storage (fuel, weapons, chaff, and flares) management.

The top edge of the PACS display shows the number of loaded external fuel tanks. The positions L, C, and R indicate the status of the left, center, and right pylons, respectively. When a fuel tank is loaded, the word "FUEL" appears beneath the pylon indicator. When a tank is not loaded, the word "PYLON" appears.

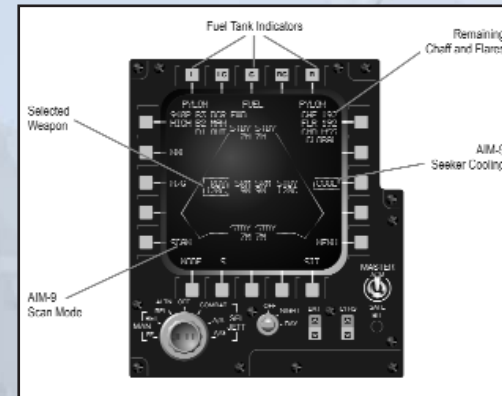

Fuel Tank Indicators

The left side of the PACS display shows two indicators. The uppermost button shows the current firing rate of the 20 mm cannon. HIGH indicates 6,000 rounds per minute; LOW indicates 4,000 rounds per minute. The number directly below the rate of fire indicates the quantity of 20 mm rounds remaining. When fired, the counter decrements in units of 10.

The SCAN indicator in the bottom-left corner will be highlighted with a box when an AIM-9 missile is selected and operating in SCAN mode. See the "Weapon Usage" chapter for full details on using SCAN mode.

The right side of the PACS display indicates the defensive stores (chaff and flares) remaining, along with weapons status. The CHF and FLR displays in the upper right indicate the number of chaff and flares, respectively. The F-15C can carry up to 120 chaff rounds and up to 60 flares.

The COOL indicator along the right edge of the PACS display indicates the overall weapons status. With the Master Arm switch in the ARM position, a box appears around the word "COOL," indicating weapons are ready. The box disappears when the Master Arm switch is in the SAFE position.

The center of the PACS display shows the loaded weapons and their status. There are eight weapon stations, four on the fuselage and two on each wing. Air-to-air

8 Aircraft Cockpits

Aircraft Cockpits 9

missiles appear in two categories: AIM-9 variants are classified as “Short-Range Missiles” (SRM), while AIM-7 and AIM-120 variants are classified as “Medium-Range Missiles” (MRM). The status for each station shows two lines based on the selected weapon type:

- When an MRM is selected: RDY appears above the selected weapon. STBY appears above all other medium-range missiles. SRM appears above all short-range missiles.
- When an SRM is selected: RDY appears above the selected weapon. STBY appears above all medium-range missiles. SRM appears above all other short-range missiles.

The following table illustrates the abbreviations used for each missile type:

Abbreviation	Missile	Range
7M	AIM-7M	MRM
120C	AIM-120	MRM
9M	AIM-9M	SRM

2.104 Airspeed/Mach Indicator

Located next to the PACS, the airspeed/Mach indicator shows the Calibrated Airspeed (CAS) and Mach number. The fixed airspeed scale, graduated from 50 to 1000 knots, and a rotating Mach number scale (synchronized so their correct relationship is shown at all altitudes) allow a single pointer to indicate both readings. The Mach number shows above 200 knots.



Airspeed / Mach Indicator

2.105 AOA Indicator

Located below the airspeed/Mach indicator, the AOA indicator displays the current Angle Of Attack in units from 0 to 45. The units are calibrated against the F-15C's normal flight envelope – a single unit does not equate to a single degree of pitch. An index mark is set at the approximate optimum landing approach AOA (20 to 22 units).



AOA Indicator

2.106 Accelerometer

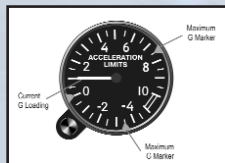

The accelerometer displays instantaneous positive and negative acceleration G-loads. Markers highlight the maximum positive and negative G-loads achieved. The instrument is independent of, and less accurate than, the G-load displayed on the HUD.

Accelerometer

2.107 Attitude Director Indicator (ADI)

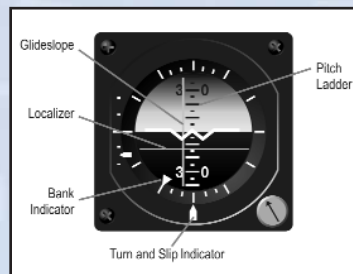

Longitudinal Aiming Mode Symbology

The Attitude Director Indicator (ADI) dominates the center of the instrument panel. The rolling attitude sphere displays the aircraft's pitch and bank angles. Pitch markings are graduated in 5-degree increments. The bank markings are graduated in 10-degree increments. During Instrument Landing System (ILS) approaches, the ILS bank steering (localizer) and glideslope bars appear in front of the attitude sphere. During ILS landings, fly toward the ILS needles.

The turn-and-slip indicator resides at the bottom of the instrument. When not centered, apply rudder toward the needle to center the indicator.

2.108 Horizontal Situation Indicator (HSI)

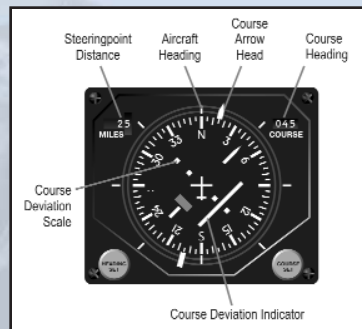

The HSI

The Horizontal Situation Indicator (HSI) shows a horizontal, top-down view of the aircraft superimposed on a compass. The compass rotates so that the aircraft heading always appears at the top of the display. The outer edge of the compass ring shows the course arrow, indicating the direction of the next navigation point.

The course deviation indicator in the center of the compass illustrates the intended course relative to the aircraft in the center of the instrument. During an ILS landing, the bar corresponds with the bank steering bar, showing deviation from the localizer beam. Please note, however, that the course deviation indicator moves the opposite direction of the ILS bank steering bar.

The desired heading is also displayed numerically on the right side of the instrument. The distance to the destination, in nautical miles, is shown on the left side of the instrument.

2.109 Altimeter



The Altimeter

The altimeter displays altitude above sea level (MSL) in 20-foot increments. It consists of a numeric readout in the center with a clock-like display along the outside edge, which graphically displays the “hundreds” of feet. In the example shown, the numeric readout shows an altitude of 29,093 feet. The needle, therefore, points to 93.

10 Aircraft Cockpits

Aircraft Cockpits 11



2.110 Vertical Velocity Indicator (VVI)

The Vertical Velocity Indicator (VVI) indicates the aircraft's rate of climb (or descent) in thousands of feet per minute. The needle counts clockwise from zero as the aircraft climbs, and counts counter-clockwise as the aircraft descends.

The Vertical Velocity Indicator



2.111 Engine Tachometer

This pair of instruments indicates the engine speed as a percentage of maximum RPM for both the left and right engines. The red band indicates afterburner.

Engine Tachometers



2.112 Fan Turbine Inlet Temperature (FTIT) Indicators

Located below the tachometers, this pair of instruments combines an analog pointer and digital readout. The temperature is shown in increments of 10 degrees centigrade. The red band indicates excessive temperature.

FTIT Indicators



2.113 Fuel Flow Indicators

This pair of instruments shows the fuel flow, including afterburner, for each engine. Flow is measured in pounds per hour.

Fuel Flow Indicators



2.114 Exhaust Nozzle Position Indicators

Located in the lower right of the instrument panel, this pair of instruments shows the exhaust nozzle position for each engine. The display shows the position as a percentage of being completely open.

Exhaust Nozzle Position Indicators

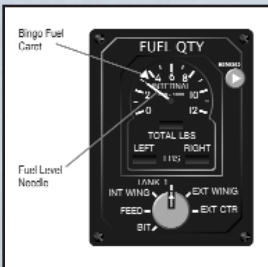

2.115 Fuel Quantity Indicator

The fuel quantity indicator shows the remaining fuel in the internal and external tanks. The needle in the center of the display shows the internal fuel, measured in thousands of pounds. Three numeric indicators show the total fuel remaining (internal and external), the fuel remaining in the left wing tank, and the fuel remaining in the right wing tank. All three displays measure the remaining fuel in pounds.

Fuel Quantity Indicator



2.116 Cabin Pressure Indicator

The cabin pressure indicator shows the current "altitude" inside the cockpit based on the air pressure in the cabin. In the event of structural damage, the cabin may lose air pressure, causing the cabin altitude to increase. If the cabin pressure altitude climbs above 10,000 feet, descend immediately!

Cabin Pressure Indicator

2.2. A-10A Cockpit

Designed specifically for Close Air Support (CAS) ground attacks, the A-10A doesn't carry radar or many of the advanced electronic systems found in other fighters. It has a much simpler cockpit dominated by navigational and engine instruments. The sole TV screen shows only images from AGM-65 Maverick seekers.



The A-10A Cockpit



2.201 TV Monitor

The TV Monitor (TVM) displays the view from the AGM-65 Maverick missile-seeker head. A description of AGM-65 displays and the targeting process is included in the "Sensors" chapter.

The TV Monitor

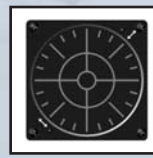

2.202 Radar Warning Receiver (RWR)

The A-10's radar warning system consists of two instruments. The Radar Warning Receiver (RWR), located in the right side of the instrument panel, listens for radar emissions (from other aircraft, surface-to-air missile launchers, etc.). It categorizes the information it "hears," displaying clues about the direction and source of the emitter. The RWR control indicator, located just below the HUD, provides additional details about the sources of radar emissions. Full usage and symbology details appear in the RWR chapter.

The RWR

12 Aircraft Cockpits

Aircraft Cockpits 13

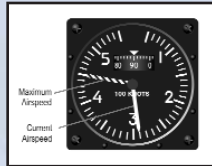

Airspeed / Mach Indicator

2.203 Airspeed Indicator

Located just below the RWR scope, the airspeed indicator shows Calibrated Airspeed (CAS) from 50 to 500 knots, and reads within 4 knots of the airspeed displayed on the HUD. The striped needle moves to show the limiting structural airspeed.



AOA Indicator

2.204 AOA Indicator

Located to the left of the Airspeed Indicator, the AOA indicator displays the current Angle Of Attack in units from zero to 30. The units are calibrated against the A-10A's normal flight envelope – a single unit does not equate to a single degree of pitch. An index mark is set at the approximate optimum landing approach AOA (20 units).

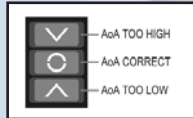

AOA Indexer

2.205 AOA Indexer

The AOA indexer sits on the canopy railing just left of the HUD. It displays three indicators comparing the current AOA with the proper landing approach AOA. When the top light illuminates, the AOA is either too high or the airspeed is too slow. When the bottom light illuminates, the AOA is either too low or the airspeed is too high. When the center light illuminates, the aircraft is maintaining the correct landing AOA. Slight errors are indicated when the center light illuminates in conjunction with one other light.

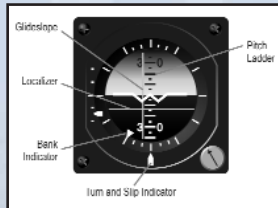

The ADI

2.206 Attitude Director Indicator (ADI)

The Attitude Director Indicator (ADI) dominates the center of the instrument panel. The rolling attitude sphere displays the aircraft's pitch and bank angles. Pitch markings are graduated in 5-degree increments. The bank markings are graduated in 10-degree increments. During Instrument Landing System (ILS) approaches, the ILS bank steering (localizer) and glideslope bars appear in front of the attitude sphere. During ILS landings, fly toward the ILS needles.

The turn-and-slip indicator resides at the bottom of the instrument. When not centered, apply rudder toward the needle to center the indicator.

2.207 Horizontal Situation Indicator (HSI)

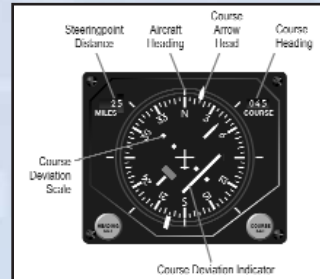

The Horizontal Situation Indicator (HSI) shows a horizontal, top-down view of the aircraft superimposed on a compass. The compass rotates so that the aircraft heading always appears at the top of the display. The outer edge of the compass ring shows the course arrow, indicating the direction of the next navigation point.

The course deviation indicator in the center of the compass illustrates the intended course relative to the aircraft in the center of the instrument. During an ILS landing, HSI the bar corresponds with the bank steering bar, showing deviation from the localizer beam. Please note, however, that the course deviation indicator moves the opposite direction of the ILS bank steering bar.



2.208 Altimeter

The altimeter displays altitude above sea level (MSL) in 20-foot increments. It consists of a numeric readout in the center with a clock-like display along the outside edge, which graphically displays the "hundreds" of feet.

The Altimeter



2.209 Vertical Velocity Indicator (VVI)

The Vertical Velocity Indicator (VVI) indicates the aircraft's rate of climb (or descent) in thousands of feet per minute. The needle counts clockwise from zero as the aircraft climbs, and counts counter-clockwise as the aircraft descends.

The Vertical Velocity Indicator



2.210 Accelerometer

The accelerometer displays instantaneous positive and negative acceleration G-loads. Markers highlight the maximum positive and negative G-loads achieved.

Accelerometer



2.211 Interstage Turbine Temperature (ITT) Indicators

This pair of instruments displays the temperature between the high and low-pressure turbine sections in degrees C.

Interstage Turbine Temperature Indicators

14 Aircraft Cockpits

Aircraft Cockpits 15



Engine Core Speed Indicator

2.212 Engine Core Speed Indicator

This pair of instruments indicates the compressor core speed as a percentage of maximum RPM for both the left and right engines.



Engine Oil Pressure

2.213 Engine Oil Pressure Indicator

This pair of instruments indicates the engine oil pressure reading in psi. If pressure drops below 27.5 psi, the engine oil pressure caution light illuminates.



Fan Speed Indicator

2.214 Fan Speed Indicator

This pair of instruments indicates the engine speed as a percentage of maximum RPM for both the left and right engines. Engine fan speed is the primary indicator of thrust being generated by the A-10A's TF-34 engines.

► Engine fan speed provides the best indication of thrust being generated in the A-10A.



Fuel Flow Indicators

2.215 Fuel Flow Indicators

This pair of instruments shows the fuel flow for each engine. Flow is measured in pounds per hour.



Flaps Indicator

2.216 Flaps Indicator

The flaps indicator shows the position of the flaps.

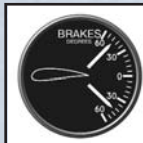

Brake Indicator

2.217 Brake Indicator

The brake indicator shows the position of the speed brake.

2.218 Fuel Quantity Indicator

The fuel quantity indicator shows the remaining fuel in the internal and external tanks. The digital readout shows internal fuel remaining. The left and right pointers indicate fuel remaining in the left and right tanks, respectively.

Fuel quantity indicator



2.219 Armament Control Panel

The armament control panel dominates the lower left side of the instrument panel, showing the quantity and status of each of the A-10A's eleven hardpoints. Each hardpoint is represented by a square of four lights.

The two upper lights in each square represent the quantity of weapons (or jamming pods) on that hardpoint. If both upper green lights are lit, there are two or more weapons on that hardpoint. If only one upper green light is lit, there is only one weapon on that hardpoint. When all weapons on the hardpoint are exhausted, the upper lights turn off and the red light on the bottom row illuminates.

The green light in the lower row indicates the "active" or selected hardpoint. Cycling through available weapons causes the green light in the lower row to move from hardpoint to hardpoint.

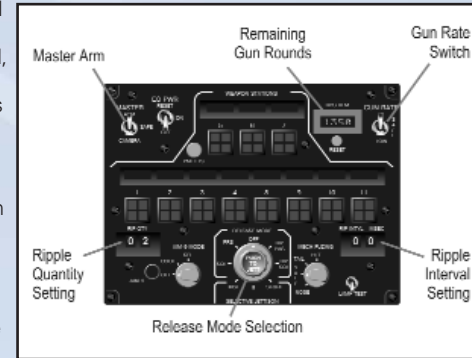

Armament Control Panel

2.220 Ripple Quantity Indicator

► Automatically releasing multiple bombs with a single press of the release button is called "rippling."

The Ripple Quantity indicator shows the number of bombs that will be released per drop.

2.221 Ripple Interval

The Ripple Interval indicator indicates the spacing in milliseconds times ten between each bomb release. For example, "50" would equate to 500 milliseconds, or 0.5 seconds.

2.222 Cannon Rate Switch

The Cannon Rate switch selects between the high (60 rounds per second) and low (30 rounds per second) rates of fire for the 30mm cannon.

2.223 Master Arm Switch

The Master Arm switch enables ARM and disables SAFE in the weapons system. The switch should be in the SAFE position during takeoff, landing, and flying over friendly territory. Switch to ARM to enable the weapons when entering hostile airspace.

16 Aircraft Cockpits

Aircraft Cockpits 17

2.3. Su-25 Frogfoot Cockpit

The Su-25 cockpit is relatively simple, dominated by a series of analog gauges. In addition, most instruments are the same as (or very similar to) Su-27 and MiG-29 cockpits.

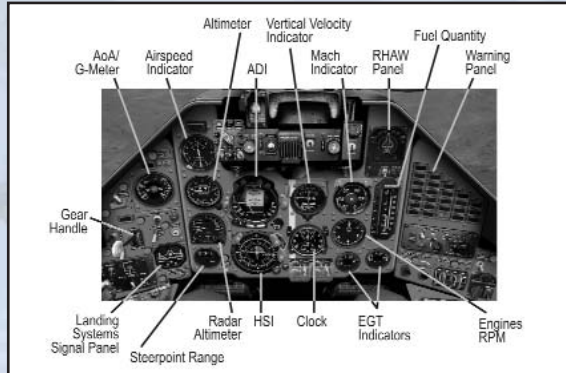

The Su-25 Cockpit

2.301 Indicated Airspeed (IAS) Indicator



The IAS indicator shows the aircraft's indicated airspeed (IAS). The scale ranges from 0 to 800 km/h.

IAS Indicator

2.302 Landing System Signal Panel

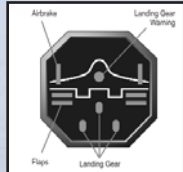

Landing System Signal Panel

The landing system signal panel shows the deployment status of the landing gear, flaps, Leading Edge Flaps (LEF), and speed brakes. The red light in the center illuminates when any of the landing gear is not locked in the position of the landing gear handle (up or down). The light flashes if one or more landing gear is locked up but the handle is down, or if the LEF are down but the handle is up.

2.303 Combined AOA/G-Meter

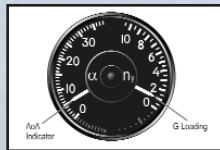

Combined AOA/G-Meter

The combined AOA/G-meter simultaneously displays the aircraft's angle of attack and current g-load. The pointer on the left shows the current AOA in degrees. The long needle on the right side of the instrument shows the current g-load.

2.304 Attitude Director Indicator (ADI)

The ADI simultaneously shows current flight attitude and course guidance information. The numeric tape in the center shows the aircraft's current pitch and bank angle. The horizontal lines remain parallel with the horizon at all times. The

turn-and-slip indicator at the bottom indicates the current sideslip. As always, apply rudder toward the sliding ball (also called "stepping on the ball") to center it.

► "Step on the ball" in the turn-and-slip indicator (apply rudder toward it) to center it and correct sideslip.

The horizontal Pitch Steering Bar in the center of the instrument indicates the correct pitch angle to reach the next waypoint. Likewise, the Course Steering Bar leans left or right, indicating the correct course to the next waypoint. When both bars are centered, the aircraft is on course.

During landings, the W-shaped glideslope deviation indicator and course deviation indicator provide Instrument Landing System (ILS) direction. If either channel of the ILS system has failed, the appropriate OFF light illuminates. During automatic landing approaches, the appearance of either light indicates an automatic level-off by the flight control system.

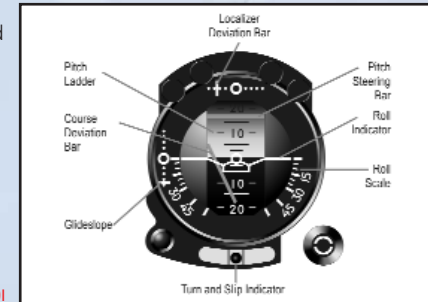

ADI

2.305 Horizontal Situation Indicator (HSI)

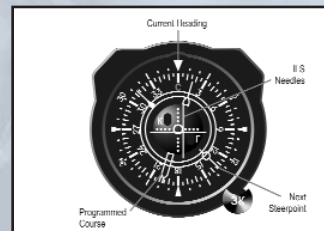

HSI

The Horizontal Situation Indicator (HSI) provides a horizontal view of the aircraft with respect to the navigation course. The compass card rotates such that the correct heading is always displayed at the very top. The course pointer shows the desired heading, while the bearing pointer points directly toward the next waypoint. The range counter indicates the distance in

kilometers to the next steer point while the bearing counter provides a numeric readout of the desired heading. ILS localizer and glideslope bars are located within the center of the compass.

2.306 Vertical Velocity Indicator (VVI)

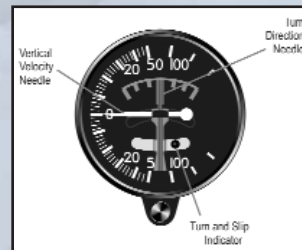

VVI

The needle moves along the left edge of the Vertical Velocity Indicator (VVI), indicating the aircraft's current rate of climb or descent. A turn-and-slip indicator in the center provides backup should the ADI malfunction. The turn needle in the center leans toward the direction of the turn, but does not provide accurate rate-of-turn information.

18 Aircraft Cockpits

Aircraft Cockpits 19



2.307 Radar Altimeter

The radar altimeter shows the aircraft's current Altitude above Ground Level (AGL), from 0 to 1,000 meters. It does not indicate altitude when above 1,000 meters.

Radar Altimeter



2.308 Engine RPM Indicator

The engine RPM indicator shows the current speed of both engines as a percentage of maximum RPM.

Engine RPM Indicator

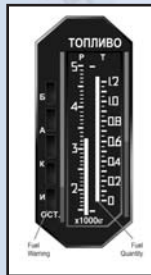

2.309 Fuel Quantity Indicator

The fuel quantity indicator shows the amount of fuel remaining onboard, from 0 to 10 tons. The white tape shows the total fuel quantity.

Fuel Quantity Indicator



2.310 EGT Indicators

The Exhaust Gas Temperature (EGT) indicators show the exhaust temperature from 200 degrees C to 1,000 degrees C.

EGT

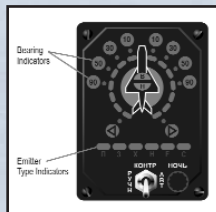

2.311 Radar Homing And Warning (RHAW) Display Panel

The Radar Homing And Warning (RHAW) panel indicates the direction and source of detected radar emitters. The Aircraft symbol represents your position; the lights around it indicate the bearing to the emitter. The six lights along the bottom indicate the radar type. See the "Radar Warning Receivers" chapter for additional details.

RHAW Display Panel

Weapons Display 2.312

In the rightmost side of the weapons console, there are two small windows displaying Cyrillic letters. These letters identify the type of weapons available in the currently selected pylons:

- **HPC: Rockets**
- **YP: Missiles (either AG or AA)**
- **B: Bombs**
- **BPY: Cannon**
- **Black and white stripes: no cannon rounds left**



Pylons #2 & #9 selected and ready (green lights). Weapon of choice: rockets (HPC). Below "HPC" it reads "BPY" meaning the cannon is operational.



Pylons #3 & #8 selected. #3 is not green because it is carrying an ECM pod, not a weapon. Pylon 8 carries a missile (YP).



Pylons #4 & #7 selected. Weapon of choice: missiles (YP). As you can see, we are moving inwards through the pylons.



Pylons #5 and #6 selected. #6 is not green because it is carrying a fuel tank. 5 carries a bomb (b).



Selecting the cannon as the active weapon is indicated by the label (BPY). In the bottom window there is a "K" meaning we have between 1/2 and a full load of ammo rounds.



As we fire the cannon, available rounds will eventually get below 1/2. This is shown by the label "1/2". If we keep firing, the next label will be "1/4". When no more rounds are left there will appear a black and white striped label.

20 Aircraft Cockpits

Aircraft Cockpits 21



2.313 ECM Light

Before engaging hostile forces it is a good idea to switch on our ECM pod. A green light will appear on the right console to inform us that we are emitting jamming noise.

2.314 Heads-Up Display (HUD)

On the base of the HUD, colored lights indicate sensor and weapon status.

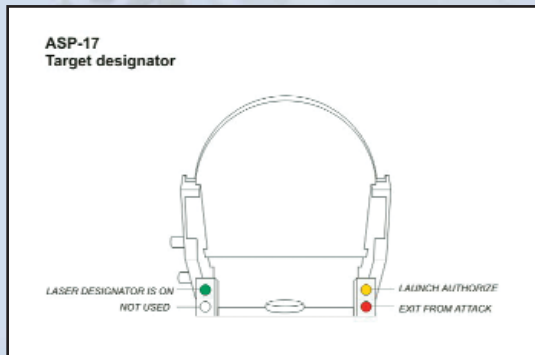

2.315 Weapons Panel

The weapons panel provides indications to inform the pilot of weapon status and type selected.

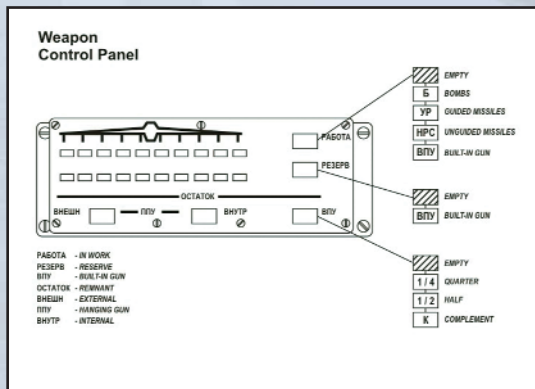

2.316 Warning Panel

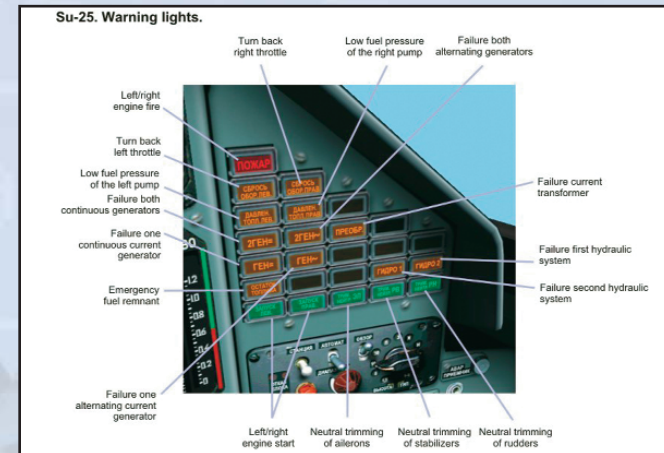

This series of lights indicates aircraft damage and system indicators.

2.4. Su-27 and Su-33 Flanker Cockpit

The Su-27 and Su-33 cockpits are extremely similar. Although some control panels differ, the instrumentation is identical between the two aircraft. Furthermore, most instruments are identical (or very similar) to the MiG-29 and Su-25 cockpits.

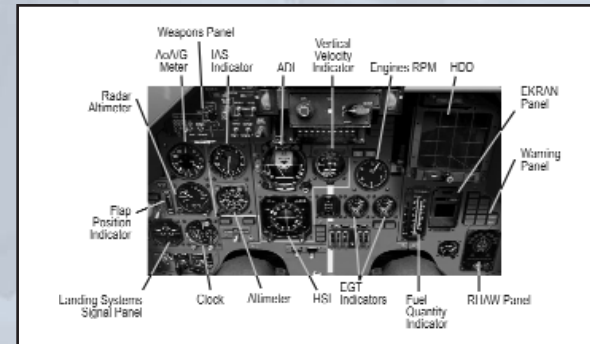

The Su-27cockpit

2.401 Indicated Airspeed (IAS) Indicator

The IAS indicator shows the aircraft's Indicated Airspeed (IAS). The scale ranges from 0 to 1,600 km/h.



IAS Indicator

22 Aircraft Cockpits

Aircraft Cockpits 23

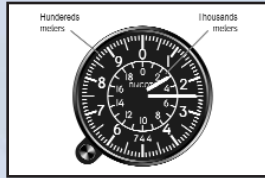

Altimeter

2.402 Altimeter

The altimeter shows the aircraft's altitude above sea level (MSL), from 0 to 25,000 meters. The inner ring and short needle show the altitude in thousands of meters. The outer ring and long needle show it in hundreds of feet. Add the two readings to obtain the exact altitude.

2.403 Landing System Signal Panel

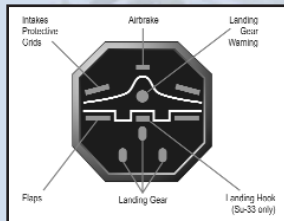

Landing System Signal Panel

The landing system signal panel shows the deployment status of the landing gear, flaps, Leading Edge Flaps (LEF), and speed brakes. The red light in the center illuminates when any of the landing gear is not locked in the position of the landing gear handle (up or down). The light flashes if one or more landing gear is locked up but the handle is down, or if the LEF are down but the handle is up.

2.404 Combined AOA/G-Meter

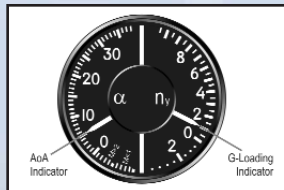

Combined AOA/G-Meter

The combined AOA/G-meter simultaneously displays the aircraft's angle of attack and current G-load. The pointer on the left shows the current AOA in degrees. The long needle on the right side of the instrument shows the current G-load. The small needle indicates the maximum G-load encountered during the flight.

2.405 Attitude Director Indicator (ADI)

The ADI simultaneously shows current flight attitude and course guidance information. The numeric tape in the center shows the aircraft's current pitch and bank angle. The horizontal lines remain parallel with the horizon at all times. The turn-and-slip indicator at the bottom indicates the current sideslip. As always, apply rudder toward the sliding ball (also called "stepping on the ball") to center it.

► **"Step on the ball" in the turn-and-slip indicator (apply rudder toward it) to center it and correct sideslip.**

The horizontal Pitch Steering Bar in the center of the instrument indicates the correct pitch angle to reach the next waypoint. Likewise, the Course Steering Bar leans left or right, indicating the correct course to the next waypoint. When both bars are centered, the aircraft is on course.

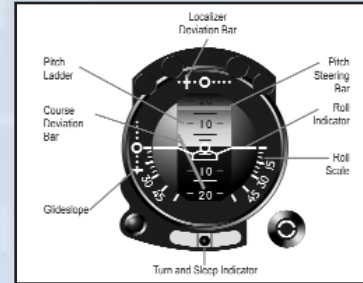

During landings, the W-shaped glideslope deviation indicator and course deviation indicator provide Instrument Landing System (ILS) direction. If either channel of the ILS system has failed, the appropriate OFF light illuminates. During automatic landing approaches, the appearance of either light indicates an automatic level-off by the flight control system.

ADI

2.406 Horizontal Situation Indicator (HSI)

The Horizontal Situation Indicator (HSI) provides a horizontal view of the aircraft with respect to the navigation course. The compass card rotates such that the correct heading is always displayed at the very top. The course pointer shows the desired heading, while the bearing pointer points directly toward the next waypoint. The range counter indicates the distance in kilometers to the next steer point, while the bearing counter provides a numeric readout of the desired heading. ILS localizer and glideslope bars are located within the center of the compass.

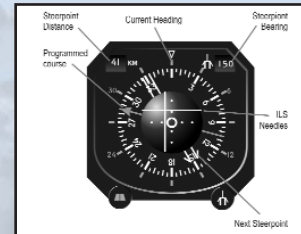

HSI

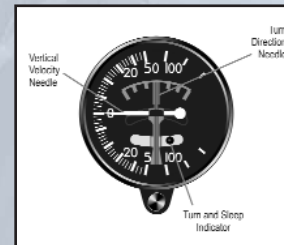

2.407 Vertical Velocity Indicator (VVI)

The needle moves along the left edge of the Vertical Velocity Indicator (VVI), indicating the aircraft's current rate of climb or descent. A turn-and-slip indicator in the center provides backup should the ADI malfunction. The turn needle in the center leans toward the direction of the turn, but does not provide accurate rate-of-turn information.

VI



Clock

2.408 Clock

The clock shows the current time of day.

24 Aircraft Cockpits

Aircraft Cockpits 25



2.409 Engine RPM Indicator

The engine RPM indicator shows the current speed of both engines as a percentage of maximum RPM. The green lights under the indicator illuminate when the afterburner engages.

Engine RPM Indicator

2.410 Fuel Quantity Indicator

The fuel quantity indicator shows the amount of fuel remaining onboard, from 0 to 9 tons. The tape in the middle shows the total fuel quantity.

Fuel Quantity Indicator



2.411 EGT Indicators

The Exhaust Gas Temperature (EGT) indicators show the exhaust temperature from 200° C to 1,000° C.

EGT



2.412 HDD

The Heads-Down Display (HDD) TV monitor fills the upper right corner of the instrument panel. The HDD displays the programmed flight path and steer points, the location of runways, and the location of targets detected by the radar. See the "Sensors" chapter for details on HDD usage.

HDD

2.413 Radar Homing And Warning (RHAW) Display Panel

The Radar Homing And Warning (RHAW) panel indicates the direction and source of detected radar emitters. The Aircraft symbol represents your position; the lights around it indicate the bearing to the emitter. The six lights along the bottom indicate the radar type. See the "Radar Warning Receivers" Chapter for additional details.

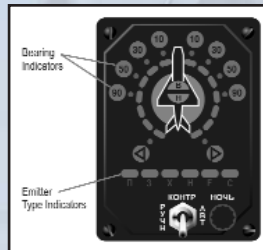

RHAW Display Panel

2.414 Warning Panel



This series of lights indicates aircraft damage and system indicators.

2.5. MiG-29 Fulcrum Cockpit

The MiG-29 cockpit is relatively simple, dominated by a series of analog gauges. The MiG-29A Fulcrum (used by NATO) and MiG-29S Fulcrum C cockpits are identical. In addition, most instruments are the same as (or very similar to) Su-27 and Su-25 cockpits.

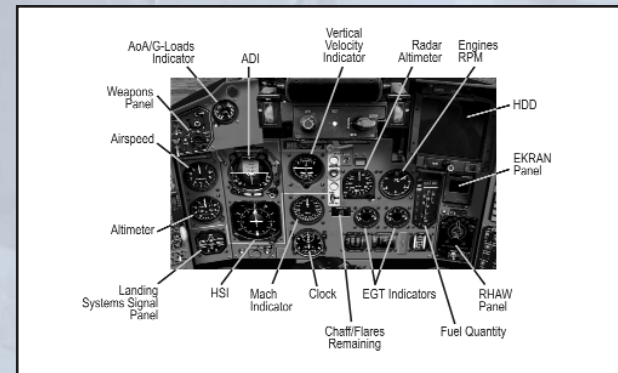

The MiG-29A and MiG-29S Cockpit

26 Aircraft Cockpits

Aircraft Cockpits 27



2.501 Indicated Airspeed (IAS) Indicator

The IAS indicator shows the aircraft's Indicated Airspeed (IAS). The scale ranges from 0 to 800 kts.

IAS Indicator



2.502 Altimeter

The altimeter shows the aircraft's altitude above sea level (MSL), from 0 to 25,000 meters. The inner ring and short needle show the altitude in thousands of meters. The outer ring and long needle show it in hundreds of feet. Add the two readings to obtain the exact altitude.

Altimeter

2.503 Landing System Signal Panel

The landing system signal panel shows the deployment status of the landing gear, flaps, Leading Edge Flaps (LEF), and speed brakes. The red light in the center illuminates when any of the landing gear is not locked in the position of the landing gear handle (up or down). The light flashes if one or more landing gear is locked up but the handle is down, or if the LEF are down but the handle is up.

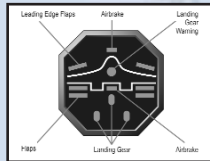

Landing System Signal Panel

2.504 Combined AOA/G-Meter

The combined AOA/G-meter simultaneously displays the aircraft's angle of attack and current g-load. The pointer on the left shows the current AOA in degrees. The long needle on the right side of the instrument shows the current g-load. The small needle indicates the maximum g-load encountered during the flight.



Combined AOA/G-Meter

2.505 Attitude Director Indicator (ADI)

The ADI simultaneously shows current flight attitude and course guidance information. The numeric tape in the center shows the aircraft's current pitch and bank angle. The horizontal lines remain parallel with the horizon at all times. The turn-and-slip indicator at the bottom indicates the current sideslip. As always, apply rudder toward the sliding ball (also called "stepping on the ball") to center it.

► "Step on the ball" in the turn-and-slip indicator (apply rudder toward it) to center it and correct sideslip.

The horizontal Pitch Steering Bar in the center of the instrument indicates the correct pitch angle to reach the next waypoint. Likewise, the Course Steering Bar leans left or right, indicating the correct course to the next waypoint. When both bars are centered, the aircraft is on course.

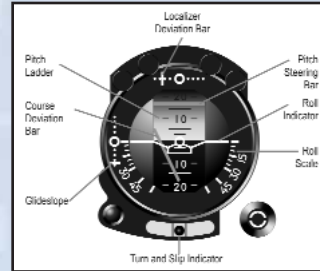

ADI

During landings, the W-shaped glideslope deviation indicator and course deviation indicator provide Instrument Landing System (ILS) direction. If either channel of the ILS system has failed, the appropriate OFF light illuminates. During automatic landing approaches, the appearance of either light indicates an automatic level-off by the flight control system.

2.506 Horizontal Situation Indicator (HSI)

The Horizontal Situation Indicator (HSI) provides a horizontal view of the aircraft with respect to the navigation course. The compass card rotates such that the correct heading is always displayed at the very top. The course pointer shows the desired heading while the bearing pointer points directly toward the next waypoint. The range counter indicates the distance in kilometers to the next steer point, while the bearing counter provides a numeric readout of the desired heading. ILS localizer and glideslope bars are located within the center of the compass.

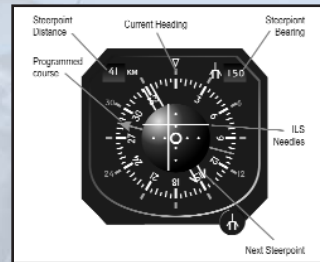

HSI

2.507 Vertical Velocity Indicator (VVI)

The needle moves along the left edge of the Vertical Velocity Indicator (VVI), indicating the aircraft's current rate of climb or descent. A turn-and-slip indicator in the center provides backup should the ADI malfunction. The turn needle in the center leans toward the direction of the turn, but does not provide accurate rate-of-turn information.

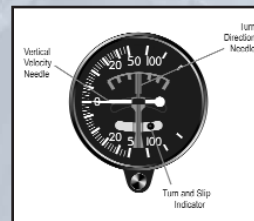

VVI

2.508 Mach Indicator

The Mach indicator shows the aircraft's current Mach number.

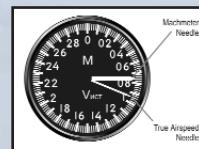

Mach Indicator

28 Aircraft Cockpits

Aircraft Cockpits 29



2.509 Clock

The clock shows the current time of day.

Clock



2.510 Radar Altimeter

The radar altimeter shows the aircraft's current Altitude above Ground Level (AGL), from 0 to 1,000 meters. It does not indicate altitude when above 1,000 meters.

Radar Altimeter

2.511 Engine RPM Indicator



The engine RPM indicator shows the current speed of both engines as a percentage of maximum RPM. Green afterburner indicators at the far right of the instrument panel indicate when afterburners are engaged.

Engine RPM Indicator



2.512 Fuel Quantity Indicator

The fuel quantity indicator shows the amount of fuel remaining on board, from 0 to 5.5 tons. The tape in the middle shows the total fuel quantity. The four triangular indicators show the amount of fuel in the centerline (CL), wing (WING), tank 1, and tank 3. The four lights illuminate as the respective tanks are emptied.

Fuel Quantity Indicator



2.513 EGT Indicators

The Exhaust Gas Temperature (EGT) indicators show the exhaust temperature from 200° C to 1,000° C.

EGT



2.514 HDD

The Heads-Down Display (HDD) TV monitor fills the upper right corner of the instrument panel. The HDD displays the programmed flight path and steer points, the location of runways, and the location of targets detected by the radar. See the "Sensors" chapter for details on HDD usage.

HDD

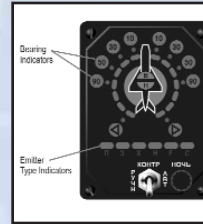

2.515 Radar Homing and Warning (RHAW) Display Panel

The Radar Homing And Warning (RHAW) panel indicates the direction and source of detected radar emitters. The Aircraft symbol represents your position; the lights around it indicate the bearing to the emitter. The six lights along the bottom indicate the radar type. See the "Radar Warning Receivers" chapter for additional details.

RHAW Display Panel

2.516 Warning Panel

This series of lights indicates aircraft damage and system indicators.

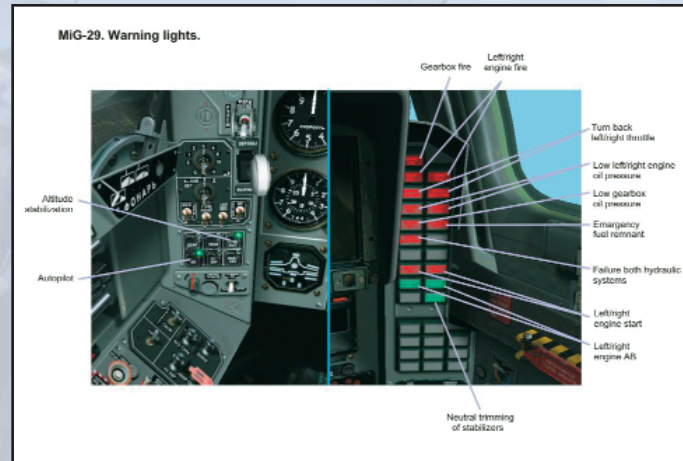

HEADS-UP DISPLAY MODES

3.1. F-15C Eagle HUD Modes

3.101 Basic HUD Symbology

Several indicators on the F-15C HUD are common to all HUD modes.

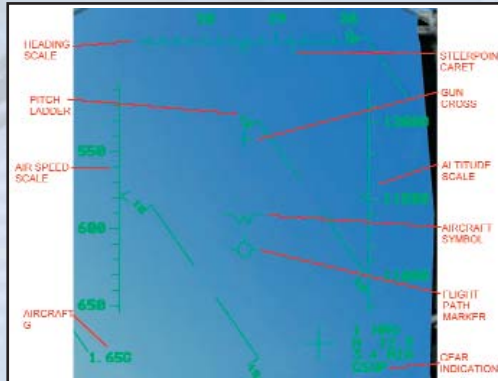

Basic HUD Symbology

- The Aircraft symbol, similar to the letter "W," appears exactly in the center of the HUD and indicates where the aircraft's nose is pointing.
- The heading scale appears along the top edge, displaying the heading rounded to the nearest ten (for example, 270 appears as 27).
- The airspeed scale on the left edge shows the Indicated Airspeed (IAS) in knots. The airspeed scale does not display values below 150 knots.
- The altitude scale on the right edge shows the aircraft's altitude above sea level (MSL) in feet.
- The velocity vector moves through the middle of the HUD, showing the direction the aircraft is actually moving, which varies from where the aircraft is heading because of momentum, sideslip, angle of attack, etc.
- The pitch scale appears in the middle of the HUD, centered on the velocity vector. Primarily, it shows the aircraft's pitch measured in five-degree increments. The entire scale moves left and right, however, mirroring the turn-and-slip indicator on the ADI. As with the turn-and-slip indicator, to stop sideslip, apply rudder toward the scale.

3.102 Navigation Mode

As the name implies, navigation mode provides navigation and steering cues. Basic navigation mode points the way to the next steer point within the programmed route. ILS mode, on the other hand, provides information required during landings.

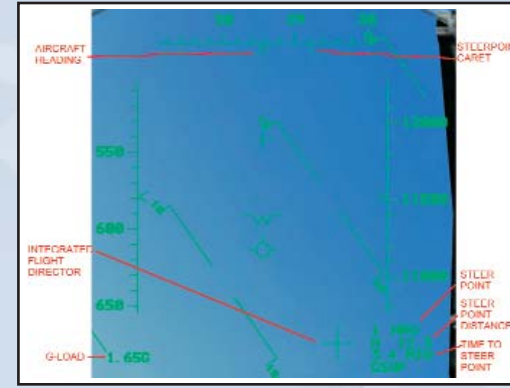

Navigation HUD

Basic Navigation

The basic navigation mode provides steering cues to the next route steer point. In addition to the basic HUD scales, navigation mode includes the following indicators:

- The mode indicator in the lower right of the HUD displays the name of the selected steer point, followed by the mode name, "NAV."
- The distance indicator beneath the mode indicator shows the distance (in nautical miles) to the next steer point.
- The time-to-go indicator, located beneath the distance indicator, shows the time to the next steer point.
- The aircraft g indicator appears in the lower-left corner of the HUD.
- The integrated flight director appears as a cross on the HUD. It points toward the next steer point, providing both pitch and bank steering cues. To fly directly to the next steer point, steer the aircraft until the flight director is centered in the HUD, directly over the Aircraft symbol.

ILS Mode

When ILS mode is engaged, the HUD displays the following indicators in addition to the basic navigation indicators:

- The mode indicator in the lower right of the HUD displays the identifier of the selected steer point, followed by the mode name, "ILSN."
- The landing gear status indicator appears in the lower-right corner, below the time-to-go indicator. It shows either GSUP (when the landing gear is raised) or GDWN (when the gear is lowered).
- The angle-of-attack scale appears on the left side, inside of the airspeed scale. The caret on the right side of the scale shows the current AOA. The scale measures AOA in units, not degrees, which range from 0 to 45. Landings should occur at approximately 22 units of AOA.
- The ILS needles appear just above the aircraft marker, near the center of the HUD. The horizontal bar represents the desired altitude; the vertical bar

32 Heads-Up Display Modes

represents the desired course. As with the ILS bars in the ADI, steer toward the bars. When the ILS bars are centered, the aircraft is following the proper approach.

To enter ILS mode, press the 1 key to cycle between enroute navigation and ILS navigation.

3.103 Gun Mode Steering

The gun mode appears after enabling the internal 20mm cannon. Different indicators appear depending upon whether a target is radar locked or not. To enter gun steering mode, you first must be in air-to-air weapons mode and then activate the gun.

Radar Search Mode

Radar search mode, also called the auto-acquisition mode, displays the basic HUD indicators plus the following additional fields:

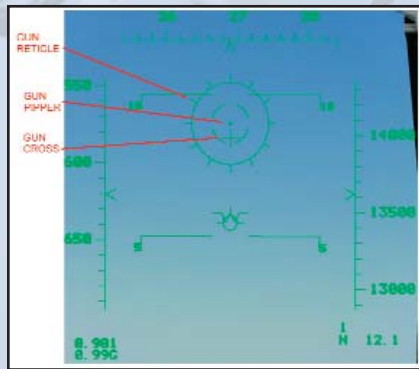

Cannon Search Mode

- The gun reticle appears just below the heading scale. In search mode, the reticle consists of a 2-mil pipper centered inside a 25-mil segmented circle, likewise centered within a 50-mil circle. The reticle does not move and provides no information except to quickly identify that the cannon is enabled.
- Gun information appears in the lower-left corner, replacing the g indicator. The word "GUN" confirms that the gun is enabled, followed by the number and type of rounds remaining. "GUN 940 P" for example, indicates 940 rounds of PGU-38 20mm rounds.
- The Mach indicator appears beneath the gun information, showing the aircraft's current Mach number.
- The navigation distance indicator appears in the lower-right corner. It shows the letter "N" followed by the distance (in nautical miles) to the next steer point.

This mode is always enabled when the radar is off, or a target has not been locked on radar.

Radar Tracking LCOS Mode

When the radar tracks a target, the HUD replaces the static reticle with the

Heads-Up Display Modes 33

Lead Computing Optical Sight (LCOS) and shows additional information about the target.

To initiate LCOS mode, you must first activate the radar and then lock the target by either manually locking the target on radar or flying the gun reticle over the target. Once the reticle is over the target and within 10 miles, an LCOS mode will automatically be initiated.

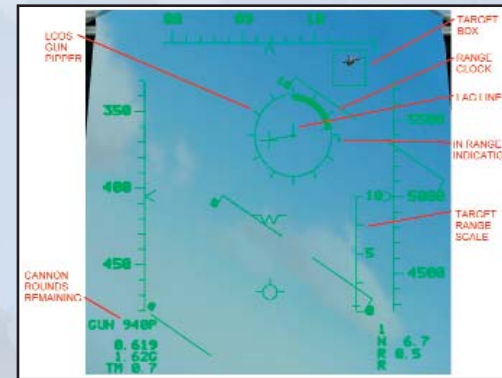

Cannon LCOS Mode

- The gun cross appears just below the heading scale. It shows where rounds will travel if the aircraft is not maneuvering.
- The target designator box appears over the locked target.
- The range scale appears on the right of the HUD, showing range from 0 to 10 nautical miles. The caret on the left side marks the range to the locked target. The number next the caret shows the target's closure rate. Tick marks indicate the AIM-9 minimum and maximum launch ranges (against a non-maneuvering target).
- The LCOS gun reticle shows where a round from the cannon will be when it has traveled the distance to the target and accounts for drop due to gravity. To ensure a hit, steer the aircraft until the reticle's center dot overlays the target designator box.

Additionally, the range bar within the reticle provides a graphical representation of the range to the locked target. Each tick mark on the reticle represents 1,000 feet of range, counting clockwise from the 12 o'clock position. The maximum range cue is located outside the reticle and indicates the maximum effective range of the cannon. When the range bar passes this cue moving counterclockwise, the target is within cannon range.

Finally, the lag line extends from the center of the reticle, indicating the pipper is displaying an error. The longer the lag line, the greater the probable targeting error.

- The range-to-target readout in the lower right of the HUD provides a redundant display of the range to the target, showing the letter "R" followed by the range to the locked target.
- Target aspect angle appears beneath the range-to-target readout, measuring

34 Heads-Up Display Modes

the angle between the target's tail and the line of sight to the target. The letter "R" or "L" appears after the angle, indicating which side of the target is presented toward the player's aircraft.

Remember: Lower aspect angles increase the effectiveness of your weapons!

3.104 AIM-9

The essential Short-Range Missile (SRM) display symbols provide weapon status and pursuit course steering. The heat-seeking AIM-9 has a seeker head completely independent from the radar. The seeker can acquire targets with or without using the radar. Once the missile is launched, it receives no further guidance from the launching aircraft.

Search Display (Seeker Boresight)

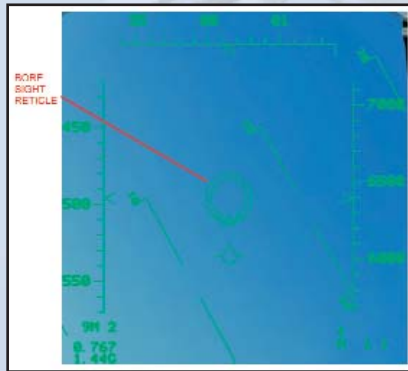

AIM-9 Boresight Mode

track, and may be launched. If the target moves outside the field-of-view circle, the missile loses the track.

Selecting SRM mode with the radar in search mode, a fixed two-degree circle appears around the Aircraft symbol. This fixed circle, aligned with the missile's line of sight, represents the missile's field of view. If the target is within visual range, you may disregard radar acquisition procedures and steer the aircraft to position the target within the two-degree reference circle.

When the missile tracks the target, the SRM tone will increase in pitch. As long as the target remains within the field-of-view circle, the missile continues to

Heads-Up Display Modes 35

Search Display (Seeker Uncaged)

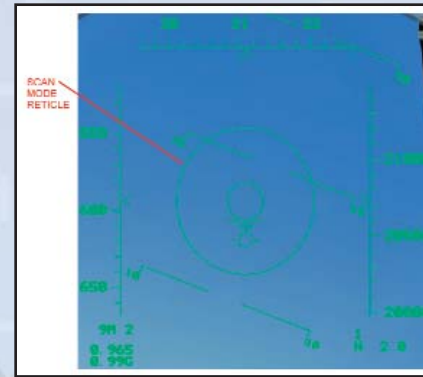

AIM-9 Seeker Uncaged

Uncaging the SRM seeker changes the HUD display. Two circles appear. The larger circle represents the missile field of view, or the entire area the seeker can move. The smaller circle represents the missile's seeker position, or where the missile is "looking" within the total field of view.

The outer, field-of-view circle always remains stationary and disappears when the missile locates a target. The inner, seeker-position circle remains fixed over the Aircraft symbol until a target is detected; then

the seeker-position circle moves to follow the target. A steady, high-pitched tone indicates the seeker is locked.

Track Display

With a radar lock established, the HUD provides substantially more information about the target. If the range to the target is greater than 12,000 feet (outside the effective AIM-9 range), the HUD provides steering cues to a launch position:

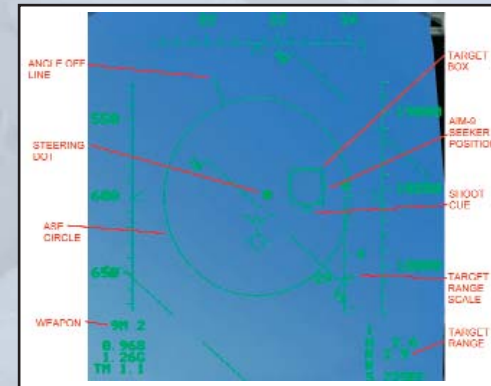

AIM-9 Target Tracking Display

- The steering dot directs the pilot where to steer the aircraft to achieve a launch position.
- The Allowable Steering Error (ASE) circle provides a frame of reference for the missile launch, representing the missile's field of view. The circle doubles in size when the missile's seeker has acquired the target. Maneuver the aircraft to place the steering dot in the center of the ASE circle.
- The angle-off line appears outside the ASE, providing a graphical

36 Heads-Up Display Modes

representation of the aspect angle. When the line is at the top of the circle, the target is moving directly away. When the line is at the bottom, the target is moving directly toward the aircraft.

► Even though the AIM-9 is an all-aspect, heat-seeking weapon, it is far more effective at lower aspect angles.

- The Target Designator (TD) box shows the target's position, tracked by the radar. Maneuver the TD box inside the ASE circle.
- The range scale appears on the right of the HUD, showing a range from 0 to 10 nautical miles. The caret on the left side marks the range to the locked target. The number next the caret shows the target's closure rate. The dark marks near the bottom of the scale indicate the missile's maximum and minimum launch range (against a non-maneuvering target). When the caret is between the marks, the target is within the missile's launch envelope.
- The data block in the lower-right corner of the HUD provides additional target information. The first line reads "R" (for radar track) followed by the range to the target (in nautical miles). The second line indicates the time it will take the missile to reach the target. The final line displays the target's aspect angle. The letter "U" appears before the aspect angle if the seeker has been uncaged (scan mode).

When the target is within 12,000 feet, additional information appears on the HUD:

- A range bar appears within the ASE circle. The range bar counts down counterclockwise, with tick marks representing the AIM-9's maximum and minimum launch ranges. A large "X" appears across the HUD when the target is closer than the missile's minimum launch range.
- A flashing, triangular "shoot" cue appears beneath the TD box, indicating conditions are favorable for a missile launch. The Master Arm switch must be enabled, the target must be within the missile's minimum and maximum launch ranges, and the steering dot must be within the ASE circle.

3.105 AIM-7

The AIM-7 is one of two Medium-Range Missiles (MRM) carried by the F-15. The semi-active AIM-7 requires the launching aircraft to maintain a radar lock for the entire flight of the missile. When using AIM-7 missiles, the HUD has four distinct modes.

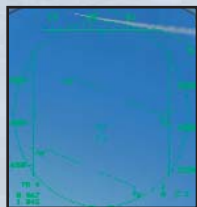

AIM-7 Relaxed Mode Display

Relaxed Display

Relaxed mode appears when selecting AIM-7 missiles without a radar-locked target. The basic navigation HUD contains a fixed reference circle, indicating the missile's field of view. The type of missile and quantity appears in the lower-left corner, above the Mach number.

Heads-Up Display Modes 37

FLOOD Mode

FLOOD mode immediately energizes a wide-area radar emission. The radar does not lock on to any targets, per se; however, AIM-7 missiles can home in on the radar reflections from targets within the flood pattern. The word "FLOOD" appears in the lower-right corner of the HUD.

The reference circle expands to illustrate the flood pattern. As long as the target remains within the reference circle, the missile will track. If the target moves outside the circle, the missile loses the track and self-destructs. If multiple targets are within the scan pattern, the missile tracks the target with the greatest radar cross-section.

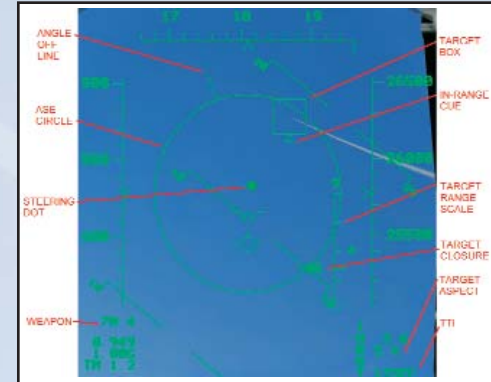

AIM-7 Target Tracking Display

Track Display

The track display appears when the radar has locked a target. The HUD provides tracking cues for the locked target:

- The Target Designator (TD) box appears over the target.
- The steering dot directs the pilot where to steer the aircraft to achieve a launch position.
- The Allowable Steering Error (ASE) circle replaces the reference circle. The ASE represents the missile's launch envelope. Steer the aircraft to bring the steering dot to the center of the ASE. In MRM mode, the ASE changes size. A smaller circle indicates greater range to the target. The ASE will flash when the radar antenna approaches the gimbal limit.
- The angle-off line appears outside the ASE, providing a graphical representation of the aspect angle. When the line is at the top of the circle, the target is moving directly away. When the line is at the bottom, the target is moving directly toward the aircraft.
- The range scale appears on the right side of the HUD. The top edge of the scale corresponds to the radar range (10, 20, 40, 80, or 160 nautical miles). Three tick marks indicate the AIM-7 minimum launch range (RMIN), the maximum launch range against a maneuvering target (RTR), and maximum launch range against a non-maneuvering target (RPI). The caret along the left side of the range scale shows the range to the target. The number next to the caret shows the target's closure rate.
- The data block in the lower-right corner of the HUD provides additional target information. The first line displays "R" (indicating a radar lock) followed by the range to the target in nautical miles. The second line displays the time it will take the next missile to reach the target. The bottom line displays the target's aspect angle.
- The data block in the lower-left corner shows the type and quantity of

38 Heads-Up Display Modes

missiles remaining on the top line. The aircraft's Mach number appears on the second line. After launching an AIM-7, the missile's Time-To-Intercept (TTI) counts down on the third line. After launching multiple AIM-7 missiles, the TTI for the last missile is displayed.

- A flashing, triangular "shoot" cue appears beneath the TD box, indicating conditions are favorable for a missile launch. The Master Arm switch must be enabled, the target must be within the missile's minimum and maximum launch ranges, and the steering dot must be within the ASE circle.

3.106 AIM-120

The AIM-120 is the F-15's primary Medium-Range Missile (MRM), having substantially improved performance over the AIM-7. Unlike the AIM-7, the AIM-120 has its own onboard radar. It uses control signals from the launching platform to get close to the target, and then uses its own radar for the final phase of flight.

Visual Mode

When selecting an AIM-120 without a radar-locked target, the HUD enters visual mode. The basic navigation HUD contains a dashed reference circle. The word "VISUAL" appears in the lower-right corner of the HUD. The type and quantity of missiles appears in the lower-left corner, above the aircraft Mach number.



AIM-120 Visual Mode

For targets within visual range, steer the aircraft to place a target within the dashed reference circle. The missile provides no indication it has acquired a target. Two seconds after launch, its onboard radar goes active, and it will track the target with the largest radar cross-section present within the circle. The AIM-120's onboard radar can detect targets up to 15 nautical miles away. If it does not detect a target after the radar goes active, the missile will perform a series of "S" turns along its original flight path. It will engage the target with the largest radar cross-section it finds.

Track Display

The track display appears when the radar has locked a target. The HUD displays tracking information for the locked target:

Heads-Up Display Modes 39

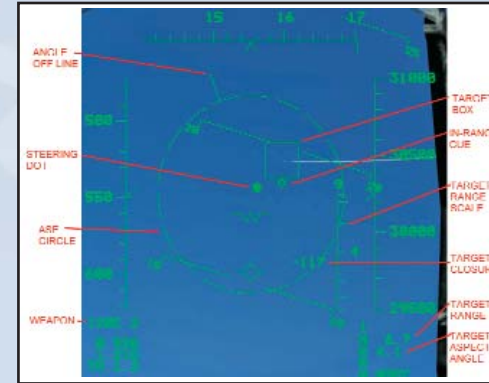

AIM-120 Target Tracking Display

- The Target Designator (TD) box appears over the target.
- The steering dot directs the pilot where to steer the aircraft to achieve a launch position.
- The Allowable Steering Error (ASE) circle replaces the reference circle. The ASE represents the missile's launch envelope. Steer the aircraft to bring the steering dot to the center of the ASE. In MRM mode, the ASE changes in size. A smaller circle indicates greater range to the target. The ASE will flash when the radar antenna approaches the gimbal limit.
- The angle-off line appears outside the ASE, providing a graphical representation of the aspect angle. When the line is at the top of the circle, the target is moving directly away. When the line is at the bottom, the target is moving directly toward the aircraft.

► Missiles are more effective against low-aspect angle targets.

- The range scale appears on the right side of the HUD. The top edge of the scale corresponds to the radar range (10, 20, 40, 80, or 160 nautical miles). Three tick marks indicate the AIM-7 minimum launch range (RMIN), the maximum launch range against a maneuvering target (RTR), and maximum launch range against a non-maneuvering target (RPI). The caret along the left side of the range scale shows the range to the target. The number next to the caret shows the target's closure rate.
- The data block in the lower-right corner of the HUD provides additional target information. The first line displays "R" (indicating a radar lock) followed by the range to the target in nautical miles. The second line displays the time it will take the next missile to reach the target. The bottom line displays the target's aspect angle.
- The data block in the lower-left corner shows the type and quantity of missiles remaining on the top line. The aircraft Mach number appears on the second line. After launching an AIM-120, the missile's time-to-active (TTA) and time-to-intercept (TTI) counts down on the third line. After launching multiple AIM-120 missiles, the TTI for the last missile is displayed.

40 Heads-Up Display Modes

- A flashing, six-pointed “shoot” cue appears beneath the TD box, indicating conditions are favorable for a missile launch. The Master Arm switch must be enabled, the target must be within the missile’s minimum and maximum launch ranges, and the steering dot must be within the ASE circle.

3.107 Auto-Acquisition Modes

The F-15’s radar supports three automatic acquisition modes. Auto-acquisition modes utilize preset scan patterns to search for close-range (less than 10 nautical miles) targets. Usage instructions for auto-acquisition radar modes can be found in the “Sensors” chapter.

► **Selecting an auto-acquisition mode with a target radar lock will break that radar lock and begin a new search.**

Boresight (BST)

In Boresight (BST) mode, the radar searches a small area directly in front of the aircraft up to a range of 10 nautical miles. The boresight reference circle appears in the HUD, centered over the Aircraft symbol. The reference circle represents the radar’s field of view in BST mode. The radar will lock the first target detected within that field of view.

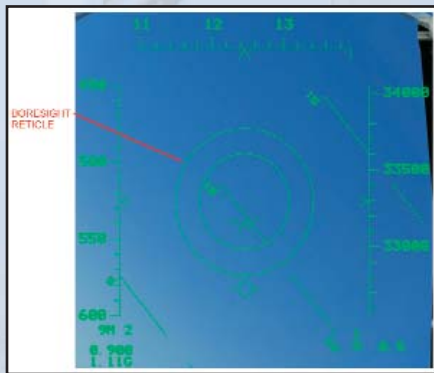

Boresight Auto-Acquisition Mode

Vertical Scan

Designed for the close-range dogfight, the vertical scan mode drives the radar antenna in a tall, narrow scan pattern 75° wide and 50° high. In this mode, a vertical-scan reference line appears in the HUD, showing roughly where the radar is searching. The radar will lock the first target detected within 10 nautical miles.

Heads-Up Display Modes 41

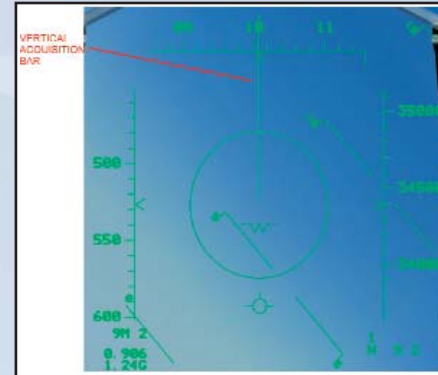

Vertical Search Auto-Acquisition Mode

Gun Mode

Gun mode provides a scan pattern +/- 30 degrees wide and +/- 10 degrees high. The radar will lock the first target detected within 10 nautical miles.

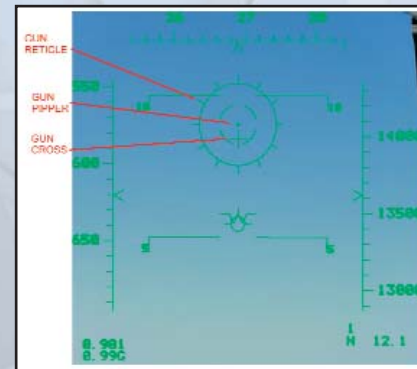

Gun Auto-Acquisition Mode

3.2. A-10A HUD Modes

3.201 Basic HUD Symbology

Several indicators on the A-10A HUD are common to all HUD modes:

42 Heads-Up Display Modes

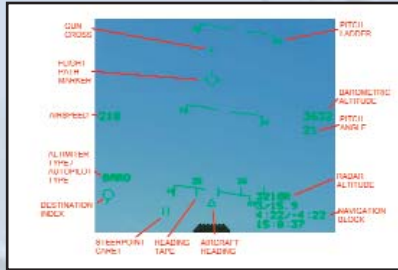

Basic A-10 HUD Symbology

- The heading scale appears along the bottom edge, displaying the heading rounded to the nearest ten (for example, 270 appears as 27).
- The digital airspeed display on the right edge shows the Indicated Airspeed (IAS) in knots.
- The digital altitude display on the right edge shows the aircraft's altitude above sea level (MSL) in feet.
- The digital pitch display appears below the altitude display on the right side of the HUD, showing the aircraft's exact pitch angle.
- The velocity vector moves through the middle of the HUD, showing the direction the aircraft is actually moving, which varies from where the aircraft is heading because of momentum, sideslip, angle of attack, etc.
- The pitch scale appears in the middle of the HUD, centered on the velocity vector. Primarily, it shows the aircraft's pitch measured in five-degree increments. The entire scale moves left and right, however, mirroring the turn-and-slip indicator on the ADI. As with the turn-and-slip indicator, to stop sideslip, apply rudder toward the scale.

3.202 Navigation Mode

As the name implies, navigation mode provides navigation and steering cues. Basic navigation mode points the way to the next steer point within the programmed route. ILS mode, on the other hand, provides information required during landings.

Heads-Up Display Modes 43



Basic Navigation Indicators

Basic Navigation

The basic navigation mode provides steering cues to the next route steer point. In addition to the basic HUD scales, navigation mode includes the following indicators:

- The radar altitude scale appears on the right side, providing an exact, radar-determined display of the aircraft's Altitude above Ground Level (AGL). A caret moves along the scale indicating the current altitude while a digital readout (followed by the letter "R") appears in the lower-right corner of the HUD.
- Information about the next steer point is presented below the radar altitude readout. The first number indicates the ID of the next steer point. The number following the "/" indicates the distance (in nautical miles) to the next steer point.
- The time-to-go indicator, located beneath the distance indicator, shows the time to the next steer point. The number following the "/" indicates whether the aircraft will arrive early or late against the assigned time to reach that steer point. A negative number indicates a late arrival.
- The current time is displayed beneath the time-to-go indicator.
- The command heading bug indicator moves along the lower edge of the heading tape, providing a steering cue to the next steer point.
- The destination index moves within the entire HUD, pointing to the next steer point.
- The text in the lower-left corner of the HUD indicates the current autopilot mode.

Mode	Function
PATH HLD	Path Hold
ALT HLD	Altitude Hold
BARO	No autopilot mode engaged

ILS Mode

When ILS mode is engaged, the HUD displays the following indicators in addition to the basic navigation indicators:

44 Heads-Up Display Modes

- The ILS needles appear just above the aircraft marker, near the center of the HUD. The horizontal bar represents the desired altitude; the vertical bar represents the desired course. As with the ILS bars in the ADI, steer toward the bars. When the ILS bars are centered, the aircraft is following the proper approach.

3.203 Gun, Rocket, and Missile Mode

The HUD displays nearly identical symbology when either the cannon, rockets, or an AIM-65 missile is selected. The radar altitude scale disappears to reduce clutter and the following additional data appears:



Typical Maverick HUD

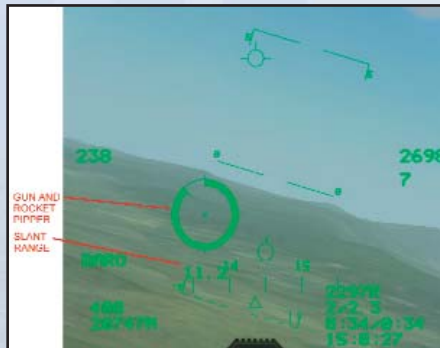

Typical Rocket HUD

- With the cannon selected, the Continuously Computed Impact Point (CCIP) gun reticle, or "pipper," appears, showing where rounds fired right now will strike. An analog range bar counts down counterclockwise, indicating the range to the point on the ground beneath the pipper. The maximum range mark near the bottom of the pipper shows the maximum effective range of the 30mm cannon.
- With an AIM-65 missile selected, the Maverick symbol appears in the HUD showing where the missile seeker is looking.
- With rockets selected, the rocket pipper appears on the HUD, indicating

Heads-Up Display Modes 45

where rockets fired right now will strike. Rockets are not extremely precise weapons, and the pipper indicates the general area where the rockets will impact.

- The selected weapon type is listed in the lower left of the HUD.
- Additional target information appears in the lower-left corner of the HUD, below the weapon type. The top number shows the elevation above sea level (MSL) of the point beneath the gun pipper or Maverick symbol. The second number shows the slant range from the aircraft to that same point.

3.204 Bomb Mode

Bomb mode is nearly identical to gun/missile mode, except the pipper/Maverick symbol is replaced with the CCIP bomb pipper.

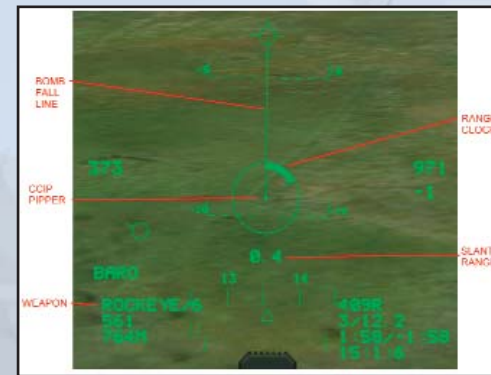

CCIP Bombing HUD

- The bomb pipper indicates where free-fall bombs released right now will strike the ground.
- The pipper includes an analog range scale that counts down counterclockwise. If the range bar exceeds the maximum-range tick mark, then the position under the pipper is too far away. Any bombs released will fall short of the target. For free-fall bombs, maximum effective range depends primarily on the altitude and airspeed of the launching aircraft.
- The bomb fall line stretches across the HUD from the gun to the bomb pipper.

3.205 Air-to-Air HUD

The air-to-air HUD provides targeting information for AIM-9 heat-seeking missiles. If the cannon is selected in this mode, an air-to-air gunnery funnel is displayed. The basic HUD is identical to other weapon HUDs, with the following additions:

46 Heads-Up Display Modes

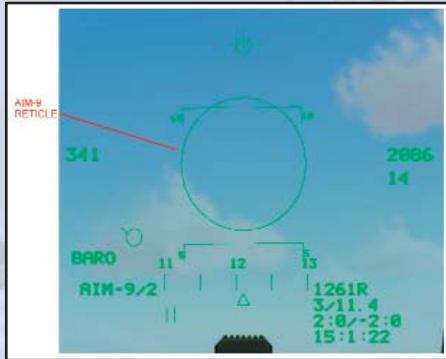

A-10 Air-to-Air HUD

- With the AIM-9 selected, a circle is shown in the center of the HUD representing the missile's field of view. To lock the weapon, steer the aircraft to bring the target within the circle. Once locked, the target must remain within the circle or the lock is lost. Uncaging the seeker head allows it to move freely and attempt to follow the target.
- Selecting the cannon brings the low-aspect gunsight funnel to the HUD. The funnel provides an estimation of a target's range. The funnel is calibrated against the typical wingspan of a fighter-sized target. Maneuver the target aircraft into the funnel. Pull sufficient lead until the wings of the target just touch the both edges of the funnel. For fighter-sized targets, this should be the appropriate lead angle to ensure the rounds strike the target. Larger-than-average or smaller-than-average targets require manually estimating the required lead angle.

3.3. Su-27 and MiG-29 HUD Modes

Introduction to Avionics & Combat Systems

LOMAC offers a complex and realistic portrayal of the real-world avionics suite found in the Su-27 and Su-33. By Western standards, these systems are generally regarded as inadequate, creating high pilot workload. To get the most out of the Flanker, you must learn how to operate its systems and how to cope with its design limitations.

All HUD displays fall into one of three categories: navigation, air-to-air combat, or air-to-ground combat. Submodes organize and display different types of information. Generally speaking, it's not necessary to utilize every submode for each category; however, each submode is designed for a particular task.

Russian vs English Displays

To create the most authentic simulation of a Russian aircraft, all displays and HUD indicators default to the Russian language with Cyrillic characters. You may, however, switch the displays between English and Russian in the Options menu under "miscellaneous." Please note: Regardless of the language used, all

Heads-Up Display Modes 47

displays will still use metric units. Altitude is measured in meters, and airspeed is measured in kilometers per hour.

Navigation

The navigation modes are your primary means of finding your way around the simulated battlefield. There are four navigation submodes.

Russian Designation	Pronounced	English Designation	Mode Type	Purpose
HAB	"nav"	NAV	Piloting	Visual navigation with a compass and stopwatch
MAPW	"marsh"	ENR	Enroute	Enroute navigation
BO3B	"vosv"	RTN	Return	Return to the Initial Approach Fix at the home airbase
ПОО	"pos"	LNDG	Landing	Activates the Instrument Landing System (ILS) and autoland feature (for carrier operations)

To select the navigation category, press the 1 key. This selects the default navigation mode, Piloting. Cycle through the various individual navigational submodes by hitting the 1 key repeatedly.

HAB-(NAV) – Piloting Submode

The piloting mode is the initial navigation submode, automatically displayed whenever you first press the 1 key while in another mode. This mode provides only minimal information. The HUD shows airspeed, altitude, and flight attitude information while the MFD shows airfields and the Admiral Kuznetsov aircraft carrier, if present. Use this mode for free-form flying without any pre-determined plan.

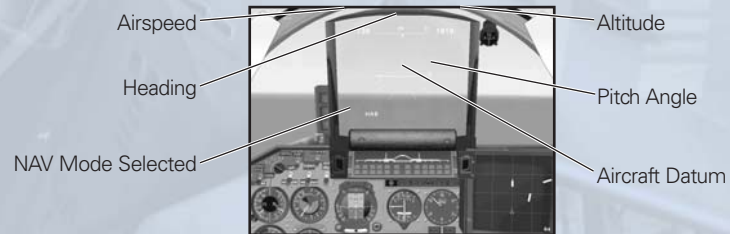

The HAB (NAV) - Piloting HUD

MAPW (ENR) - Enroute Submode

The MAPW (ENR) submode is the primary navigation submode, enabling the pilot to fly the pre-determined mission flight profile. Select it by pressing the 1 key while in the initial NAV or piloting mode. Each waypoint is characterized by its coordinates on the ground, its altitude, and the desired airspeed for that leg of the trip. This mode displays the required speed and altitude of the waypoint in small characters located above the actual speed and altitude readouts of the aircraft. A circle or navigation reticle inside the HUD points the way to the next waypoint. Maneuver the aircraft to center the navigation reticle in the HUD and you're heading directly to the next waypoint. Numbers in the center of the HUD's bottom edge indicate the distance to the next waypoint in kilometers.

48 Heads-Up Display Modes

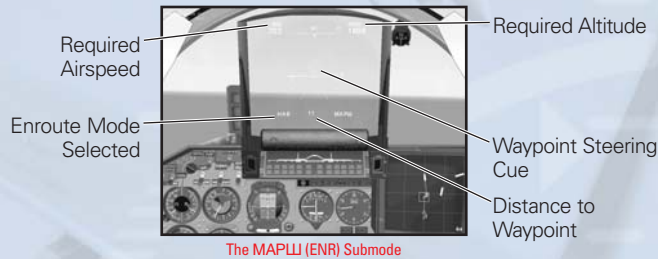

The MAPW (ENR) Submode

Backup Instruments

The instrument panel also provides navigation information. The MFD symbolizes your position, the waypoint, and the desired flight path to the next selected waypoint. The ADI yellow predictor bars ("needles") mark the desired bank and pitch angles while the HSI shows the required heading and distance to the next waypoint. In general, if the HUD becomes unserviceable, you can still navigate using the instrument panel.

The **MAPW** (ENR) submode provides no combat information. Generally speaking, select this mode, set your course, and then select a more appropriate combat mode. Occasionally return to **MAPW** (ENR) mode to verify your flight path. Press the ~ key to cycle through waypoints.

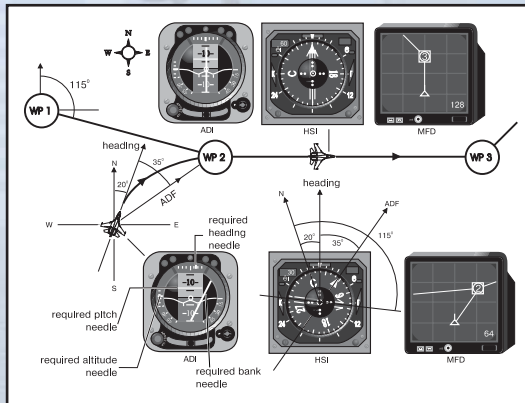

Reading the MAPW (ENR) Submode instrumentation

In the figure above, the aircraft on approach to waypoint 2 is misaligned by about 35° to the left. This is reflected on the HSI (see the instruments at the bottom of the figure): the current heading is 20 and the ADF arrow (the narrow needle) reads 55°. The distance to waypoint 2 is 30 km (upper-left corner of the HSI). The desired radial, the desired flight path from waypoint 1 to waypoint 2, is shown by the flight path marker (the wide needle). In other words, the ADF needle points directly to the next waypoint while the flight path marker points to the pre-programmed flight path to that same waypoint.

The ADI also shows the misalignment between the aircraft's heading and the next waypoint. The required bank needle points to the right, indicating the aircraft

Heads-Up Display Modes 49

needs to turn to the right to reach the next waypoint. If the aircraft were on course, the needle would point straight up. The required altitude needle on the left of the ADI shows that the aircraft is quite close to the desired altitude.

If the aircraft is on the planned flight path, as is the aircraft between waypoints 2 and 3 in the same figure, then the wide and narrow arrows on the HSI are aligned and pointing straight up. Likewise, the required bank needle on the ADI is also pointing straight up.

BO3B (RTN) - Return Submode

The **BO3B** (RTN) submode directs you to the Initial Approach Fix (IAF) for the runway you are landing at. Think of the IAF as the last waypoint before reaching the airbase, where you will intercept the Instrument Landing System (ILS) and begin your approach. For all intents and purposes, **BO3B** (RTN) is identical to **MAPW** (ENR) except that **BO3B** (RTN) only has one waypoint: the IAF for the runway.



The BO3B (RTN) - Return Submode

You select the **BO3B** (RTN) submode by pressing the 1 key twice from the initial NAV mode. You may cycle through the available runways and their IAFs by pressing the ~ key.

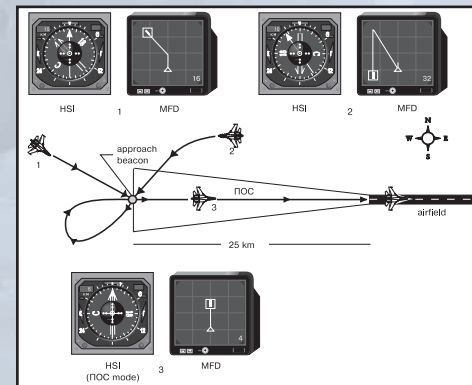

Reading the BO3B (RTN) - Return Submode Instrumentation

When flying towards the IAF, the wide arrow on the HSI always indicates the bearing from the beacon to the selected airfield and normally is the same as the runway heading. The figure above illustrates the readings of the HSI and the MFD

50 Heads-Up Display Modes

for three aircraft with different positions relative to the approach beacon. Aircraft 1 is 10 km from the beacon and flying a heading of 135, on track to the IAF. Aircraft 2 is 10 km from the IAF, flying a heading of 270. The misalignment between the current heading and the required heading is 35°. In other words, the pilot must turn 35° to the left to fly directly to the IAF. Aircraft 3 is flying the runway heading, between the runway and the IAF. In this case, the MFD shows only a straight line from the runway to aircraft marker.

When the aircraft reaches the IAF, the navigation software automatically switches to the **ПОО (LNDG)**, or landing, submode.

П (LNDG) Landing Submode

You can, however, switch directly to landing submode by pressing the 1 key repeatedly until the GJC (LNDG) indicator is displayed on the HUD. If the airfield is equipped with an ILS, the Glideslope and Localizer bars are displayed. A vertical velocity scale will appear on the right side of the HUD. The ideal touchdown should occur at a sink rate of 1 to 1.5 m/s.



The ПОО-(LNDG) Landing Submode with ILS

Radar and Electro-Optical System

The weapons control system (WCS) of the Su-27 and the Su-33 integrates the weapon and target data and parameters from the following components:

- The Zhuk-27 or Miech-33 airborne radar
- The 36-Sh Electro-Optical System (EOS)
- The onboard weapons management software
- Individual weapon targeting hardware and software
- The data presentation system (MFD and the HUD)
- The Parol (Password) Identification Friend or Foe (IFF) interrogator, which processes signals from air and ground installations equipped with pertinent transponders
- The Helmet-Mounted Target Designator (HMTD)
- Target data feed from AWACS

Zhuk-27 Radar (Su-27 and SU-33)

The Phazotron Zhuk-27 (Beetle) coherent pulse-Doppler jam-proof radar is fitted with a twist cassegrain antenna of 700 mm in diameter and has the following features:

Air-to-Air Mode

- Look/down-shoot/down capability
- Range While Search of up to 24 contacts
- Track While Scan of up to 8 contacts

Radar Cross Section (RCS) of the target, or the size of the reflecting surface of the target, has a substantial impact on radar detection performance. In general, large targets reflect more radar energy, so a B-52 can be detected farther away than an F-16. For a target with an effective RCS of 3 m² (a typical-sized fighter), the Zhuk-27 has a maximum detection range of 150 km (93 miles) when facing the target's forward hemisphere and 55 km (34 miles) when facing the target's rear hemisphere.

The radar transmits radio pulses of nearly equal frequency (within the X-band) and phase (coherent radiation). The radar measures the range to the target by timing how long it takes for the reflected waves to return to the transmitter. The greater the range, the longer it takes the waves to return. When the pulses are reflected from a moving target, the frequency shifts due to the Doppler effect. Pointing the radar at the ground, naturally, results in lots of radar reflections appearing on the scope. These returns are called ground clutter. Most modern radar systems take advantage of the Doppler effect and filter out any returns that are stationary, thus filtering out the extra returns from ground clutter. This does have one side effect, however, an airborne target that has no movement relative to the transmitter appears stationary and is filtered out. This condition typically occurs when the target moves perpendicular to the transmitter, and therefore appears stationary (in terms of how fast the transmitter is closing on the target). This effect is called "beaming" and is an effective defense against airborne radars.

You toggle the radar by pressing the I key. The Radar Cue **И** (Russian "I," stands for "illumination") on the left of the HUD indicates that the radar is active. If the Radar Cue does not appear when you enable the radar, this means that the latter is damaged.

36-Sh Electro-Optical System

The radar is backed up by the 36-Sh electro-optical system (EOS) designed by the NPO Geophysica. The EOS can acquire thermally contrasting targets with high accuracy. It combines a laser rangefinder (effective tail-on range of 8 km/5 miles) and Infra-Red Search and Track (IRST) system (maximum effective range of 50 km/31 miles). These use the same optics, which consist of a periscopic system of mirrors and an articulated glass sensor ball mounted centrally in front of the windscreen. The sensor ball moves in elevation (-15° down and +60° up) and in azimuth (60° left and 60° right of center, respectively). The information update rate depends on the field-of-view size and varies from 2 (search in wide area) to 0.05 (autotrack mode) seconds.

The EOS operates passively (emits no detectable signal) by receiving infrared emissions from the target. This allows the pilot to prepare a surprise attack on the enemy. Maximum detection ranges depend on the attack geometry. It changes from 15 km for forward-hemisphere attacks to 50 km for attacks in the rear hemisphere. The range to a target can be accurately measured only at relatively close distances (from 200 m to 3 km). In order to measure distances outside laser range when a target is locked (Tab key), the radar sends short strobe bursts or pulses towards the contact. Once the contact comes within 9 km, the strobe

52 Heads-Up Display Modes

pulse ceases and the laser rangefinder takes over. These pulses are extremely short and difficult to detect with accuracy, thus providing little opportunity to locate the source. You mainly use the EOS to provide targeting data for air-to-air missiles with an IR seeker head and for tracking targets in a gun fight.

To toggle the EOS, press the O key. The EOS Cue **T** (stands for "Thermal") on the left side of the HUD indicates that the EOS is active. If the EOS Cue does not appear at all, this indicates that the EOS is either damaged or not correctly selected.

The EOS, radar, or a missile's seeker can be slaved to the pilot's Helmet-Mounted Target Designator (HMTD), allowing the pilot to target simply by moving his head in the direction of the enemy aircraft. This is extremely convenient for acquiring agile targets at visual ranges.

Since the principles of using the radar and the EOS are practically the same, we describe these principles for the various combat modes in the same place, pointing out distinctions as needed.

Scan Cone Basics

To understand how the radar/EOS searches for targets, imagine walking through a forest with a flashlight on a pitch-black, moonless night. You can only see objects illuminated by the flashlight beam, and the beam grows weaker as it extends from the light bulb. This essentially describes the problems of using radar to search for targets. In simple terms, the radar extends something like a cone in front of the transmitter. The farther it goes, the bigger the cone gets. Objects outside of the cone will pass undetected. As a result, it is necessary to turn the aircraft occasionally and to "slew" the scan cone using the command keys on the facing page.

Objects inside the cone will reflect radar energy back toward the transmitter, but radar waves lose power as they travel. If they travel far enough, they eventually dissipate. Consequently, contacts at long range may not reflect enough radar energy; the reflected waves dissipate before making it back to the transmitter. Therefore, if the radar energy can travel 150 km, bounce off a target, and return 150 km to the source, then the radar energy is also capable of travelling at least 300 km in a straight line. This means that the enemy can detect your radar transmissions from well outside of your effective search range!

The EOS works similarly, except that it is a passive system; instead of looking for reflected radar waves, it looks for heat emitted by targets. As a general rule, hotter targets (fighters using afterburner) can be detected further away. Also, rear-aspect targets (with the heat source pointed at the EOS) will generally be detected further away than nose-aspect targets (since the enemy aircraft is blocking the view of the engine exhaust).

Air-to-Air Combat

During an attack on an airborne target, the pilot usually goes through the following steps: search, locate, track, identify, and attack. He can accomplish these steps both with and without the radar and/or the Electro-Optical System (EOS). The selection of one or other type of weapon mainly depends on the range to the target and the possibility of tracking the target using the onboard radar or EOS.

The table below is a summary of the keys you will often use in air-to-air combat.

Key	Action
I	Toggle radar
O	Toggle EOS
Tab	Place designated contact in Track While Scan from Scan
Ctrl-Tab	Remove tracked contact from Track While Scan
Tab	Lock tracked target to Attack Mode
Tab	Lock/unlock target to Attack Mode in CAC submodes
; (Semicolon)	Move HUD target designator UP
, (Comma)	Move HUD target designator LEFT
. (Period)	Move HUD target designator DOWN
/ (Slash)	Move HUD target designator RIGHT
Shift + ; (Semicolon)	Move radar/EOS scan zone UP in BVR modes
Shift + , (Comma)	Move radar/EOS scan zone LEFT in BVR modes
Shift + . (Period)	Move radar/EOS scan zone DOWN in BVR modes
Shift + / (Slash)	Move radar/EOS scan zone RIGHT in BVR modes
Ctrl+I	Center radar antenna/IRST ball
- (Minus)	MFD/HUD Zoom in
+ (Plus)	MFD/HUD Zoom out
D	Cycle through weapons
C	Enable/disable cannon
Ctrl+V	Toggle Salvo mode
Ctrl+W	Jettison weapons/Load Weapons, step-by-step

Air-to-Air Mode Summary

The following table lists the different avionics modes available for air-to-air combat. Note that they fall into three categories: beyond visual range, close air combat, and longitudinal missile aiming.

Flight / Combat Mode	Russian	English	Key	Purpose
Beyond Visual Range - Scan	ДВБ-ОБЗ	BVR - SCAN	2	Acquire up to 24 targets at 25 km to 150 km ranges
Beyond Visual Range -Track While Scan	ДВБ-СНП	BVR - TWS	2	Tracking up to 8 contacts while scanning up to 16 more
Beyond Visual Range - AWACS Datalink	ДВБ-ДРЛО	AWACS	2	Using AWACS information for attacking targets when radar and EOS is off - (requires AWACS)
Close Air Combat - Vertical Scan	БВБ-ВС	CAC - VS	3	Dogfight at ranges from visual to 25 km
Close Air Combat - Radar Bore Site	БВБ-СТР	CAC - BORE	4	Aim using forward looking boresight of radar beam
Close Air Combat - Helmet	БВБ-ШЛЕМ	CAC - HMTD	5	Aim using helmet-mounted target designator
Longitudinal Aiming	ФИО	LNGT	6	Aiming using a missile's seeker at ranges from visual up to max IR/active range of missile
Attack	ДВБ-АТК БВБ-АТК ФИО-АТК	BVR-АТК CAC - АТК ФИО - АТК	Tab	Auto-tracking one target (Target Locked)

ДВБ (BVR) Beyond Visual Range Mode

In ДВБ (BVR) Beyond Visual Range mode, both the radar and the EOS scan in a limited area - the scan cone has angular dimensions of 10° in the vertical plane (elevation scan angle) and 60° in the horizontal plane (azimuth scan angle). You can move the radar/EOS scan zone within the gimbal limits of the antenna/seeker. The scan zone dimensions of the radar are 120° x 120°, the EOS dimensions are 120° horizontal, 60° up and 15° down (see the figure below). The radar beam scans an area 2.5° tall, requiring four passes to cover the entire scan cone. Each pass takes

Heads-Up Display Modes 53

54 Heads-Up Display Modes

about 0.5 seconds. Information on each radar contact, therefore, is updated every two seconds.

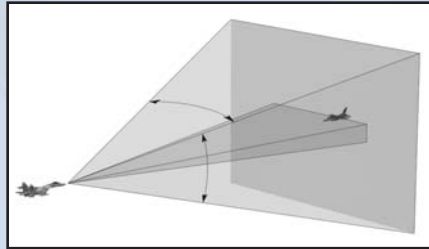

In BVR mode, the radar antenna is stabilized in roll and pitch. This means that the direction of the antenna axis does not change when the aircraft banks, pulls up or dives, providing that the aircraft maneuvers do not exceed the gimbal limits of the antenna. Unlike in many Western aircraft, the beam shape of the Su-27's radar is

fixed and cannot be changed. The maximum detection depends on the target's characteristics (geometry, aspect angle, radar reflectivity, etc.). Typically, the radar can detect a medium-sized target such as a MiG-29 at a range of about 100–120 km. Large targets such as strategic bombers can be detected at distances up to 150 km.

Target	Maximum Detection Range in Scan Submode, Km
B-52	150
F-111	80
F-16	50
F-117	@10

As with the radar, the field of search of the electro-optical system is stabilized in roll and pitch. The EOS can detect medium-sized targets located up to a maximum of 50 km, but, as described above, cannot accurately measure the range to a target beyond 5 km.

Tracking data appears on both the HUD and the MFD, depending on the mode and submode selected. In most cases, the MFD shows a top-down view of the area around your aircraft. Your current position is indicated by the small aircraft symbol; the number in the corner indicates the distance from the bottom edge to the top edge in kilometers. HUD and MFD symbology appropriate to each mode and submode are described in the following sections.

ДВБ (BVR) mode has two submodes of operation: Scan and Attack. The following sections describe each mode.

ДВБ – ОБ3(SCAN) Scan Submode

Pressing the 2 key selects **ДВБ** (BVR) mode in the **ОБ3** (SCAN) submode of operation. This is your primary, long-ranged search mode. It detects contacts (depending on RCS) from 25 to 150 km away, displaying up to 24 contacts on the HUD. This mode does not provide any detailed information about a specific contact. You'll know the azimuth (how far the contact is off your nose) and distance. You can also establish the contact's elevation by the correlating image return and scan beam "illuminator" on the right side of the HUD.

Heads-Up Display Modes 55



To gather more information about specific contacts of interest, steer the HUD target designator box over the desired contact (using the joystick coolie hat or the keyboard controls). Designate the target by pressing the Tab key.



Attack (ATK) Submode

The Attack submode is common to all air-to-air modes. In short, you are requesting the radar to focus all its energy onto one specific aircraft contact.

56 Heads-Up Display Modes

Depending upon which mode you are operating (BVR, CAC), the method of selecting or designating that contact differs, but the end result is the same: The radar/EOS will automatically track the aircraft contact, hence the term "auto-track." In common language, this is called "the lock." The radar/EOS receives all the necessary contact parameters from the Weapons Control System to smoothly move the antenna in the direction of flight for the contact. The following parameters are available on the HUD while the radar is in auto-track:

- Aspect angle relative to user aircraft
- Azimuth/Elevation relative to user aircraft
- Distance relative to user aircraft
- Speed of contact

The radar tracking area for a single target is 120° x 120° in elevation and in azimuth, and tracking range for a medium-sized target is from 55 km (rear hemisphere) to 100 km (forward hemisphere for large aircraft). When operating in Attack mode, the radar provides target designation for guided missiles, illuminates targets for missiles fitted with SARH seekers, and provides initial guidance data for active missiles.

If you use the EOS, the tracking area coincides with its field of search and equals 75° in elevation (15° down, 60° up) and 120° in azimuth. Tracking range depends on the type of target, strength of the heat signatures, and the attack hemisphere. The EOS laser rangefinder measures distances to the target for ranges from 0.2 to 3 km, with an accuracy of 10 meters and from 3 to 5 km with an accuracy of 25 m.

After the radar (EOS) has locked onto the target, the HUD shows the following information: the "A" Autotrack Cue, the range scale with the minimum and maximum launch range marks, and the target aspect-angle arrow. The HUD also displays the Aiming Reticle, altitudes and true airspeeds of your aircraft and of the target, the aircraft datum and bank scale, current combat mode, type of missile, quantity of missiles, and missile flight time. The target's position is shown on the HUD as a point (the Target Marker) in angular coordinates scaled to the dimensions of the tracking area (see the figure below).

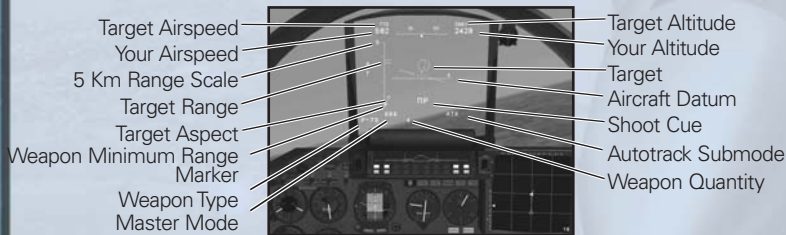

Autotrack Symbology with Radar Lock

Green lights on the weapon readiness panel indicate which missiles at each weapon station are ready for launch. The MFD displays a top-down view of the target, its aspect angle, and distance information about the target. When you are tracking the target using the radar, target information may disappear for some time if the target deploys ECM or decoy countermeasures.

Heads-Up Display Modes 57

The HUD will also display the ПП Shoot Cue or OTB Reject Cue (pronounced "o-te-ve," stands for "Turn Away" in Russian). In English, the Shoot Cue designator is LA for "Launch Authorized," and the Reject Cue designator is No LA for "No Launch Authorized." The Shoot Cue informs you that the selected missile is ready for launching and the target is within the missile's reliable launch parameters. Fire the missile by pulling the trigger (Space Bar). The Reject Cue warns that you are too close to the target and prohibits launch. If you lock onto friendly aircraft, the IFF will detonate СВОЙ, meaning "Ours."

If the radar or the EOS switches to autotracking from Helmet mode, cross-hairs superimpose on the Targeting Circle (see the figure below). When the HUD gets the Shoot Cue, the Targeting Circle flashes at a frequency of 2 Hz. If the onboard computer does not get target range information, the Targeting Circle flashes with a frequency of 1 Hz (this is common when using the EOS).

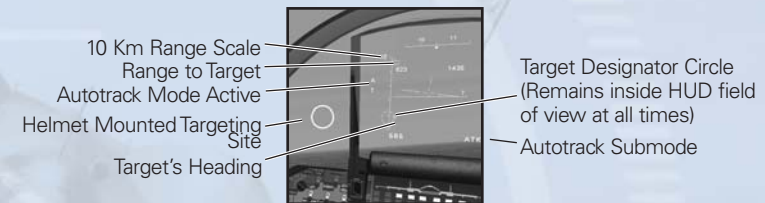

4-17: Autotrack Symbology with Helmet-Mounted Sight

When tracking a target in Attack mode, maneuver your aircraft so that the Aiming Reticle stays close to the HUD centre datum. This eases your workload when the target is not very visible and prevents the target from breaking the lock. Remember, if you use the EOS, the flashing of the Shoot Cue with a frequency of 1 Hz warns you that the system is not measuring the range to the target.

Keep in mind that for SARH missiles, it is necessary to illuminate the target for the entire flight time of the missile. After launch this will be represented by the A (Autotrack) Cue flashing at 1 MHz. So know your missiles!

If the target leaves the tracking area, or you break the lock by pressing the Tab key, or the target is destroyed, the radar (the EOS) returns to the submode that preceded the Autotrack. Similarly, if the radar or EOS is damaged or you switch sensors off, the lock breaks and the radar returns to the submode that preceded the Autotrack.

ДВБ - ДРЛО (AWACS) AWACS Datalink

The Flanker's ability to datalink with AWACS aircraft allows pilots to locate and stalk targets without ever engaging onboard sensors. This form of "stealth" lets the Flanker close on its prey without betraying its presence. A friendly AWACS aircraft (an A-50 or E-3) must be airborne simultaneously to your aircraft. The datalink information can be viewed on the MFD in all combat modes as well as from the NAV modes; however, these contacts can only be selected for targeting from the BVR mode. While in BVR mode, if there is a friendly AWACS aircraft airborne, a datalink will be established, and contacts detected by the AWACS will appear on the MFD as standard aircraft symbols (friendly and enemy). The AWACS contacts will appear more subdued (less bright) than regular contacts. Turn on radar at least once to establish data link.

58 Heads-Up Display Modes



AWACS's Datalink Active

Contacts

ДРЛО (AWACS) Submode

HUD Scaling Considerations

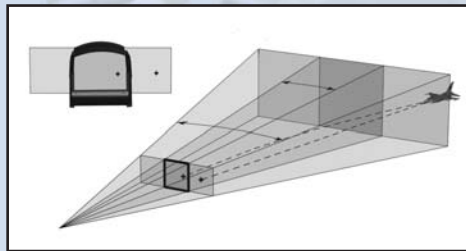

Target Positions are Scaled to Fit the HUD

Keep in mind that the scan zone for submodes is larger than the area covered by the HUD. Targets are therefore "scaled" to fit the dimensions of the HUD. The target marker in the HUD, consequently, points toward the target but is not an accurate indicator of the target's azimuth and elevation. The gimbal

markers on the MFD will give you a better idea as to how close the gimbal limit for the target is, and you will easily interpret off-boresight angle.

Acquiring a Target in ДББ (BVR) Mode Step-by-Step

Let's walk through the process of acquiring a BVR target.

Step 1. Switch to BVR Mode.

Press the 2 key and check that the HUD Mode Indicator shows the notation of the ДББ – ОБЗ (BVR - SCAN). If there is a friendly AWACS aircraft airborne ОБЗ (SCAN) will be replaced by ДРЛО (AWACS). Use the + and - keys to adjust the range displayed on the MFD and the HUD.

If you have an AWACS datalink, then you will almost immediately receive contact data on the MFD: Friend or foe, distance, and aspect angle. (See above for more on AWACS). If this is the case, you can cycle through the contacts on your MFD by selecting the tilde (~) key. Then go to step 5.

Step 2. Select a Sensor.

Activate the radar or EOS. The notation at the left of the HUD should read И (I) or Т (T) for the radar and EOS, respectively. Alternatively, the HUD will display ДРЛО (AWACS) if a friendly AWACS aircraft is airborne and in range.

Step 3. Direct Scan Zone.

Using the Shift - coolie hat on your joystick or the scan zone control keys, aim the scan cone in the portion of airspace you wish to scan. The HUD will immediately show detected contacts, if any.

Heads-Up Display Modes 59

BVR Mode Selected



Track and Lock Submode Selected

The ОБЗ (SCAN) Submode Symbology

Step 4. Locking up the Target.

To select a particular target, steer the HUD Target Designator Box (HTD Box) onto the contact of interest and press the Tab key. The contact will switch from being scanned to tracked. This method is called "manual selection," since you are selecting an individual contact to be tracked by the radar.

Scanned Contacts

Selected Contact



Tracked Contacts

Range Bar

Scan Submode

Tracked Contacts

The ЧИП Submode Symbology

60 Heads-Up Display Modes

Heads-Up Display Modes 61

Step 6. Select Air-to-Air Missile and Launch.

Select the appropriate air-to-air missile for the range and type of target by pressing the D key. Consider range, maneuverability, size, and speed of the target. Once the target is within the launch parameters of the weapon and the Launch Cue is displayed in the center of the HUD, you are authorized to fire the "weapon."

БББ /Close Air Combat Mode

The БББ (CAC) Close Air Combat mode is used for attacking targets that you have spotted visually or that are known to be within close range (less than 25 km). The radar (the EOS) locks onto a target in an area limited by the angular dimensions of the HUD, namely $20^\circ \times 20^\circ$ ($\pm 10^\circ$ in azimuth and $\pm 10^\circ$ in elevation). The ШЛЕМ (HMTD) submode permits the pilot to acquire targets with greater off-boresight angles.

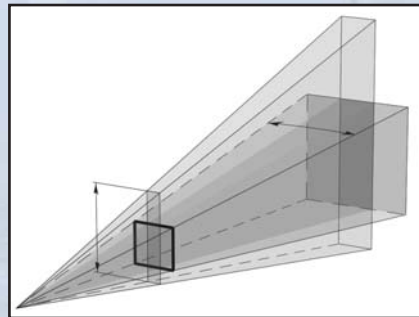

The БББ Scan Cone

БББ-МС (VS) Vertical Scan Submode

The first submode, called Vertical Scan submode, is depicted on the HUD by a narrow vertical band. This submode can be selected by pressing the 3 key. It is designed to acquire targets in a dogfight. Both radar and EOS are active, but this mode is very stealthy, as the radar is not constantly emitting. It is "primed" and ready in a standby mode, ready to send a very strong and fast scan along the $25^\circ/60^\circ$ Vertical Scan cone. The HUD will display a P (which is the Russian R) on the left side of the HUD to denote "ready" or standby, as well as the T for the EOS. Any contact detected and designated (locked) within the cone will

immediately stop the scan process and focus a 2.5° circular beam on the target, switching the submode to Attack (ATK).

Maneuver your aircraft so as to position the visually acquired target within the limits of the Vertical Scan Bar portrayed in the center of the HUD. The actual scan cone extends 20° above and behind the HUD. This means that you can lock a target even if you position it within that imaginary extended band. You can also steer the Vertical Scan cone (band) left and right 10° by using the target designator key commands.



The Vertical Scan Mode Close Air Combat Symbology

БББ-СТР (BORE) Boresight Submode

The second submode, entitled Radar Boresight, scans in a narrow 2.5° circular beam, which can be steered up, down, left, and right (using the target designator controls) within the angular limits of the HUD, $20^\circ \times 20^\circ$. This mode is used to focus the radar on a specific target, and is especially useful in crowded airspace. Activate the СТР (BORE) submode by pressing the 4 key. By steering the beam directly to the desired target, you reduce the risk of accidentally locking the wrong target. Similar to the Vertical Scan submode, the radar is not illuminating continuously but is on standby and primed to send out a strong circular pulse to the target. If the radar receives a return pulse, the system switches immediately to Attack mode.



The Boresight Mode Close Air Combat Symbology

Acquiring a Target

To acquire a target at close ranges, proceed as follows.

Step 1. Switch to CAC Mode.

Press either 3 or 4 to select the desired БББ (CAC) submode. Make sure that the HUD mode indicator shows the БББ (CAC) notation.

62 Heads-Up Display Modes

Step 2. Select a Target.

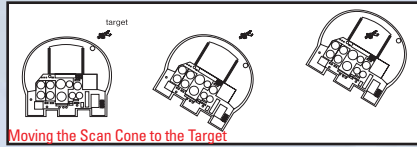

Once you have visually spotted a target, place it in the field of view of the HUD by maneuvering your aircraft and/or Vertical Scan or Boresight scan cones.

Step 3. Lock onto the Target.

To lock onto the target, press Tab. Failing locking conditions, the Autotrack Cue flashes at a frequency of 2 Hz. In this case, press Tab until **A** turns permanent. The radar/EOS switches to Autotrack mode, as evidenced by the change of information on the HUD and MFD. If several targets are within the field of view of the HUD, the equipment tracks the target that has been detected earliest. You may have to press Tab several times to obtain a lock.

ШЛЕМ (HMTD) Helmet Mode

This is also a Close Air submode that, while visually similar to the Boresight submode, is very different. This submode can be activated by selecting the 5 key. The Helmet-Mounted Target Designation (HMTD) system frees the pilot from having to boresight his enemy by slaving the radar and the EOS to the helmet-mounted sight. Once you have acquired the target, the Helmet mode allows you to keep your eye on the target at all times by turning your head in the direction of the target's motion. The real-world system works by using a pair of head position sensors on the cockpit panel, on each side of the HUD.

The radar (the EOS) locks onto the target in an area limited by the 2.5° scan cone. The pilot should keep the cone within the limits of the radar/EOS field of search. That means that you cannot use your helmet-mounted sight to acquire and lock onto targets beyond the gimbal limits of the radar antenna or the IRST sensor ball.

Acquiring a Target

Use the following procedure to lock a target with the IKTV (HMTD) mode:

Step 1. Switch to Helmet Mode.

Press the 5 key. The HUD submode indicator displays the notation IKTV (HMTD) (pronounced "shlem," denotes "Helmet" in Russian) on the lower-right corner of the HUD. The targeting circle appears in front of you and follows the movement of your head.

Heads-Up Display Modes 63

Step 2. Select a Target.

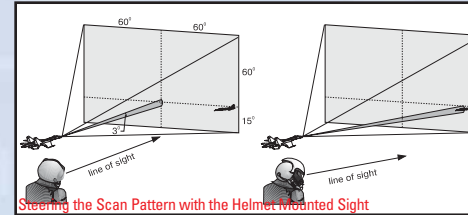

Once you have visually spotted a target, place it within the targeting circle by maneuvering the aircraft and turning your head in the direction of the target. You can move your head using the joystick coolie hat or the numeric keys on the keypad. In so doing, the targeting circle moves with

your head. The figure above illustrates how you search for a target when the EOS is slaved to the HMTD system. To padlock your eyes onto the target, press * (asterisk) on the keypad.

Step 3. Lock onto the Target.

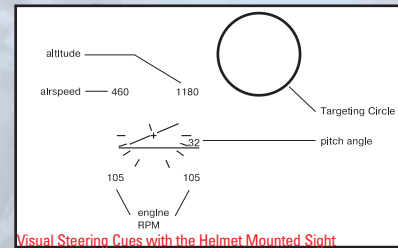

To place the HMTD onto the padlocked target, use either the joystick coolie hat or the scan cone keys. Once the circle is on the target, press the Tab key. The HMTD is now padlocked to the target (along with your eyes) and the weapons control system is put into the Autotrack mode.

If the HUD gets out of view, a set of visual cues appears next to the targeting circle. These cues indicate your airspeed and altitude, the aircraft datum and pitch angle, and the engines RPMs (105% for both engines in the figure above).

64 Heads-Up Display Modes

Heads-Up Display Modes 65

ФНО / Longitudinal Missile Aiming Mode

Should the radar or the EOS be damaged, you can still use the direct targeting capability of missiles fitted with IR or active radar seeker heads. This requires placing the target into the seeker's field of vision and locking on. The seeker tracks the target in an area limited by its gimbal limits and by the tracking range. The latter depends on the type of missile, type of target, and attack geometry.

Longitudinal Missile Aiming

You use the ФНО (LMA) mode for attacking a visible airborne target in a dogfight by selecting the 6 key. The missile seeker locks onto the target in an area limited by the angular dimensions of the seeker's field of vision (about 3°), which is aligned along the longitudinal axis of the aircraft. The seeker head locks onto the target within 2-3 seconds.

To lock onto a target in ФНО (LMA) mode, perform the following steps:

Step 1. Switch to Longitudinal Missile Aiming Mode.

To do this, press the 6 key. If the selected missile has a seeker head of an appropriate type, the HUD shows the fixed aiming reticle (3°) and the seeker aligns itself along the longitudinal axis of the aircraft. The weapon readiness panel shows the selected missiles.



Step 2. Select a Target.

Once you have visually spotted a target, place it within the Aiming Reticle by maneuvering your aircraft.

Step 3. Lock onto the target

Enter targeting data into the seeker head by pressing the Tab key. If the locking conditions are met, the seeker locks onto the target and starts tracking it. We'll describe the seeker track mode in a separate section below.

Seeker Track Mode

After a missile seeker has locked onto the target, it switches to track mode, continuously keeping the target within the seeker's field of view. The dimensions of the single target tracking area depend on the type of missile and are limited by the gimbal limits of the seeker head and sensor sensitivity. Gimbal limits may range from 20° (the R-60 Aphid) to 80° (the R-77 Adder). Tracking range depends on the type of target and specifications of the seeker head, and may vary between 5 km and 30 km.

When the seeker tracks a target, the HUD shows the following information: altitude and true airspeed of your aircraft, aircraft datum and bank scale, type of missile, and quantity. The HUD mode indicator displays ABJ (LMA). Lock onto the target is evidenced by the movable aiming reticle showing an angular position of the seeker head, and by the Shoot Cue GH.

You should maneuver the aircraft so that the movable aiming reticle stays close to the HUD center datum. This eases aiming at the target and prevents the target from breaking the lock.

If the target leaves the tracking area of the seeker head, or you break the lock by pressing Tab, or the target is destroyed, the HUD returns to the mode that immediately preceded the track mode ФНО (LMA).

3.4. Su-25 HUD Modes



The anti-radar missiles Kh-58 and Kh-25 MP are very easy to use; fly the nose of your plane towards the electromagnetic source and lock the target pressing the Tab key. The pipper will then center to the emission source, the distance to the target, and the minimum launch distance in the outer circle. Since these are fire and forget missiles, once launched you can look for another emission sources if you have enough missiles, of course.

The laser-guided missiles Kh25L and Kh-25ML are a bit more complicated to manage, as they need the pilot to manually designate the target. First, you need to establish visual contact with the target and begin a gradual descent. The auto-throttle feature can be very useful.

With the nose of your plane pointing at the target, turn on the laser pressing the 0 key. The pipper appears in the HUD, and you will need to move it over the target. When it is over the target, pressing the Tab key will lock it. The pipper is now fixed at the selected point and shows us the slant range distance and the minimum launch distance indicators.

Information provided by the marks at the ring of the pipper:

Dynamic Indicators

- The narrow arc is the slant range distance indicator (moves counter-clockwise).
- The wide arc shows the remaining distance to the minimum launch distance (moves counter-clockwise).
- The small triangle that you can see at twelve o'clock is a bank indicator.

Static Marks

- Each long line indicates 1000 m of slant range distance to target.
- Each short line indicates 250 m of slant range distance to target.

Once locked, you can still move the pipper. So it's important to launch the missile well before we arrive at the minimum distance; we can continue making fine adjustments after that. Note that the wide arc disappears when we are at the minimum launch distance.

66 Heads-Up Display Modes

In the following two images you can see the launch sequence. At the left, note we are arriving at the minimum launch distance but we have the piper in the correct position, so it's time to launch the missile. At the right image you can see how we continuously adjust the piper after the missile has launched, to keep it over the targets, as they are mobile units.

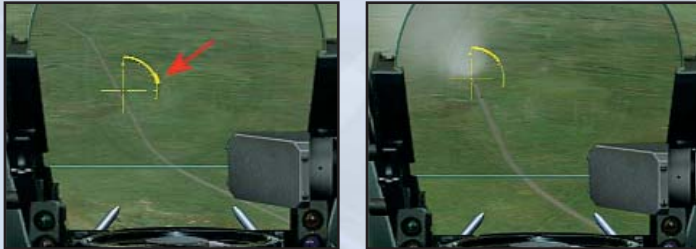

Attacking ground targets with rockets should be done with a stable approach to the target. Remember to activate the laser ("0" key) to get the correct indications from the piper (a green indicator will light up). When in launch range, a red indicator will light up and the outer circle of the piper will show the slant range distance.

Air to air attack mode



Select Air-to-Air mode and check in the inventory panel that we have the short range defense missiles selected.

To attack with Air-to-Air missiles, it is enough to visually locate the target, lock on it with the Tab key and stay in range to shoot. The distance to the target is indicated in two ways: the red warning light below the HUD, which will turn on when in range, and the outer circle of the piper (as said before, long lines mean 1000 m and short ones 250 m).

Heads-Up Display Modes 67

Attacking with guns is similar in simplicity; the important thing is to maneuver the plane to get a good fire position, obviously.



SENSORS

In many aerial battles, the victim never saw the attacker. Technological advancements now let the pilot “see” targets as far away as one hundred miles. Radar, laser, and infrared sensors extend the pilot’s view, giving “first look, first shot” capability.

4.001 Radar

Radar is an active sensor, meaning it broadcasts energy. This energy travels through the air, strikes targets, and is reflected back to the emitter. The radar measures how long it takes the pulse to return, the angle of the radar antenna, and the frequency shift of the returned pulse. Comparing multiple returns over time lets the radar calculate the target’s range, altitude, speed, heading, aspect angle, and closure rate.

Radar is not perfect, though. As the pulse travels through the air, it loses energy. When it bounces off a target, it loses more energy. Traveling back to the emitting aircraft, it loses yet more power. Successfully detecting a target requires the return pulse having sufficient energy to be detected by the radar system. The more amount of energy reflected by the target is called the Radar Cross-Section or RCS. The larger the RCS, the farther away the target can be “seen.”

► **The larger the object’s RCS, the greater the range at which it can be detected.**

Modern radar relies on the Doppler Effect and the resulting frequency shift in the return pulse to glean information about the target. To minimize “clutter” caused by reflections from the ground, radar systems filter out stationary targets based upon measuring the Doppler shift in the return pulses. Unfortunately, this same mechanism filters out aerial targets flying perpendicular to the emitter. This is known as “beaming” the radar and is an effective tactic to break hostile radar lock ons.

► **“Beaming,” or flying perpendicular to a radar emitter, is an effective tactic against Doppler-based radars.**

Radar does not cover the entire sky. Imagine searching for armed opponents in a large, darkened room filled with furniture with only a small penlight to guide you. The flashlight beam covers a very small percentage of the room, so you must move it around a lot to avoid obstacles and prevent the bad guys from sneaking up on you. Likewise, the radar system must move the beam as it scans the sky. However, the larger the volume of the scan pattern, the longer it takes the radar to complete a single scan. Fast-moving, nimble fighters might pass through the scanned area undetected if the scan pattern is too large.

Unfortunately, using a flashlight in a darkened room reveals your position to your adversaries. Likewise, radar emissions announce your presence to everyone around. Most modern combat aircraft carry Radar Warning Receiver (RWR) gear that listens for and analyzes radar emissions. By measuring the characteristics of the received pulse, the RWR can often identify the radar system and therefore identify the opponent’s aircraft type.

Radars operate in a variety of modes, varying the rate pulses that are transmitted and the size of the scan pattern. The number of pulses emitted per second is

called the Pulse Repetition Frequency (PRF). Radars in “searching” modes generally use larger scan patterns and a lower PRF, letting the radar monitor multiple targets. Radars in “tracking” combine small scan areas with a high PRF. The radar then reports significantly more information about one target, and continually adjusts the scan pattern to maintain focus on the target. This is commonly called a “lock on.”

Many modern radar systems attempt to bridge the gap between search and track radar modes with Track While Scan (TWS) modes. TWS modes attempt to provide detailed tracking information about multiple targets while continuing to scan a large volume of airspace. On the positive side, this provides a substantially more thorough picture of the sky. On the downside, the radar must make “educated guesses” about the tracked targets, since the radar cannot focus attention on any single target. Based on information collected when the radar beam scans a given target, the radar predicts the target’s flight path until the beam again scans that target. While the beam is busy scanning other targets, the radar display shows the predicted position of the first target. If that makes a sudden, unexpected maneuver, the radar display continues to show the predicted position until the radar beam finally returns its attention to the target and finds it gone.

► **TWS mode provides details for multiple targets simultaneously, but relies on estimations of the target’s position, and can therefore be “tricked” if a target makes an unexpected maneuver.**

4.002 Infrared

Engines, especially jet engines, produce a lot of heat. Weapon designers quickly realized they could detect and track this heat, or *Infrared* (IR) energy. Early IR systems could only track targets from behind, with the hot engine exhaust pointed directly at the seeker. Modern all-aspect heat-seeking missiles can track the heat emitted from a target from any angle. Further, many aircraft carry Infrared Search and Track (IRST) systems, which can detect targets many miles away. IRST systems are passive, meaning they emit no energy of any kind. Unlike radar, which announces the emitter’s presence to the world, IR systems are completely “stealthy” and impossible to detect.

► **Weather, such as rain and fog, seriously degrades IR performance. In severe weather conditions, IR systems suffer greatly shortened detection ranges.**

4.003 Laser

Laser systems provide modern combat aircraft with a third major sensor system. Laser rangefinders calculate distance very accurately by bouncing a laser beam off the target and measuring how long it takes the beam of laser light to return to the emitter. Ground-attack systems use lasers to pinpoint specific objects (such as an individual battle tank or a specific window on a building) to guide air-to-ground weapons. Since lasers, like radar, emit energy, laser emitters can be detected by hostile forces.

As with IR systems, laser systems work best in clear weather. Clouds, fog, and rain seriously degrade laser systems.

4.1 F-15C Eagle Radar Modes

4.101 Range While Search (RWS) Mode

RWS mode is the F-15C's primary, long-range search mode. The pilot specifies a maximum scan range (10, 20, 40, 80, or 160 nautical miles) and chooses the height and width of the scan pattern. The radar displays targets found within that volume of airspace, but does not provide detailed information about any given contact.

The VSD shows a top-down view of the sky, with the bottom line representing the aircraft's position and the top line representing the maximum search range (20, 40, 60, 80, or 160 nautical miles away). Contacts appear on the VSD based on their range; the closer they are, the farther down the display they appear. The VSD search range automatically adjusts to a lower or higher setting as contacts approach the bottom or top edges, respectively. Up to 16 contacts can appear simultaneously on the VSD. The radar automatically issues an IFF (Identify Friend or Foe) query when it detects a contact. Friendly contacts appear as circles; hostile and unidentified contacts are shown as rectangles.

The left edge of the VSD describes the height of the scan pattern, called the *elevation*. The height of the elevation is measured in 2.5-degree units called *bars*. The elevation may be set to 1, 2, 4, 6, or 8 bars in height. The two circles on the left side of the VSD move, representing the size of the elevation scan. The numbers next to the circles indicate the upper and lower altitudes of the scan pattern at the selected search range. Additionally, the entire scan pattern may be moved 30 degrees above or below the aircraft's center line. The elevation caret moves up and down indicating the current elevation of the radar antenna as it moves through the scan pattern.

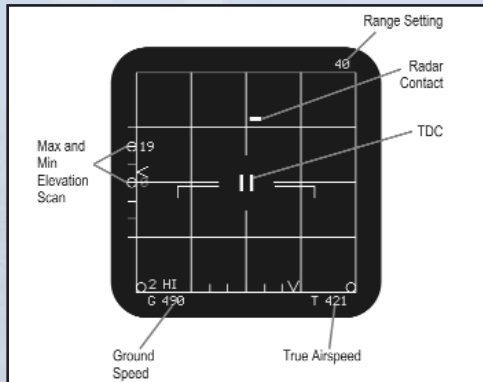

RWS Mode

The bottom edge of the VSD also shows the scan pattern's width, called the *azimuth*. The azimuth may be set to either +/- 30° or +/- 60° wide. The circles along the bottom of the VSD move to indicate the current width of the radar scan pattern, and the azimuth caret moves between the circles, indicating the current horizontal position of the radar antenna.

The lower edge of the VSD shows several pieces of information. The aircraft's ground speed (G) and true airspeed (T) appears below the VSD. The elevation bar selection appears in the lower-left corner of the VSD. The radar automatically interweaves high and medium Pulse Repetition Frequency (PRF) pulses through the scan pattern, displaying the current PRF value (HI, MED, or LOW) next to the elevation bar setting.

► Larger patterns take longer to scan. Fast-moving targets can move completely through the pattern undetected before a radar beam reaches that portion of the scan.

Two other indicators appear within the VSD. The aircraft waterline appears centered in the VSD, providing an indication of the aircraft's bank angle. This helps the pilot maintain control while concentrating on the VSD. Additionally, two parallel vertical bars, called the Acquisition symbol, let the pilot lock onto specific targets. Move the Acquisition symbol over a specific target, and press the Designate key to lock the target and switch the radar to Single Target Track mode.

4.102 Single Target Track (STT) Mode

After radar-locking a specific target, the radar switches to STT mode. STT mode uses a fixed scan pattern centered on the specified target, displaying information only on that target and ignoring all other contacts. The basic VSD format remains identical to RWS mode, but substantially more information appears. The STT indicator appears in the lower-left corner. The Contact symbol changes to the Primary Designated Target (PDT) symbol.

► You must either lock a target and enter STT mode, or activate FLOOD mode in order to launch an AIM-7 missile.

The *non-cooperative target recognition* system automatically attempts to identify the locked target. The target must be within 25 nautical miles and must be facing the player with an aspect angle between 135° and 225°. The aircraft type or "UNK" (for "unknown") will be shown below the VSD.



STT Mode

Target airspeed, aspect angle, and heading appear above the VSD's upper-left corner. The target's altitude MSL appears next to the elevation caret on the left edge. For example, 17,200 ft would be displayed as "17-2." The range caret appears along the right edge, with the target's closure rate displayed next to the caret. Numerical bearing-to-target and range-to-target values appear in the lower-right corner.

Significant missile targeting information dominates the VSD in STT mode. First, the Allowable Steering Error (ASE) circle appears in the center. The size of the circle depends on the currently selected missile type and the target's position, speed, heading, etc. Maneuver the aircraft to bring the steering dot within the ASE circle to maximize the missile's chances of intercepting the target.

The Missile Range Cues RMIN (minimum launch range of the selected missile), the RTR (maximum range against a maneuvering target), and RPI (maximum

72 Sensors

Sensors 73

range against a non-maneuvering target) indicators are shown along the VSD's right edge. Additionally, a triangle marks the RAERO, or absolute maximum aerodynamic range of the selected missile. The missile Shoot Cue, along the bottom edge, indicates when the target is within acceptable launch parameters. The Time-To-Intercept (TTI) counter shows the number of seconds a missile will take to reach the locked target.

After a missile launch, another timer appears along the top edge, next to the range display. After launching an AIM-7, the display shows a "T" and counts down the TTI for that missile. After launching an AIM-120, the display shows a "T" and counts down the Time-To-Active (TTA) for that missile. Once the missile goes active, the display shows an "M" and counts down the time until the missile impacts the target.

4.103 Track While Scan (TWS) Mode

TWS is a powerful, but somewhat difficult, radar mode. As the name implies, it combines elements of both RWS and STT modes. Using a fixed-size, unchangeable scan pattern, TWS provides detailed tracking data on multiple targets while continuing to scan the entire pattern. Initially, the TWS display is virtually identical to the basic RWS display, except the letters "TWS" appear in the lower left corner and the altitude (in thousands of feet MSL) appears above each contact. You cannot change the size of the scan pattern, but you can move the position of the scan cone.

► You must use TWS mode to fire multiple AIM-120 missiles simultaneously at multiple targets.

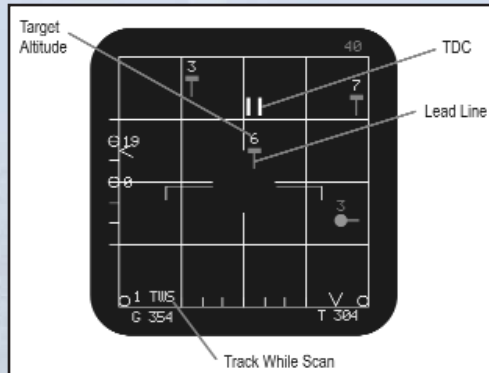

TWS Mode with PDT and SDT

indicates the target's altitude. The number to the right of the box shows the target's sequence number. Designating the PDT or any SDT a second time switches the radar to STT mode.

When firing multiple AIM-120 missiles, the first missile tracks the PDT. Subsequent missiles engage the SDTs in numerical sequence. That is, the second AIM-120 missile engages SDT number 1, the next missile engages SDT number 2, etc. The VDT shows contact information and missile flyout data for the PDT just like STT mode.

Unlike RWS, designating a target does not switch the radar to STT. Instead, you may designate up to eight separate targets simultaneously. The first target, the Primary Designated Target (PDT) is indicated with the usual "Lock On" symbol. Up to seven more targets may be designated, called Secondary Designated Targets (SDTs), which are marked with hollow rectangles. The number above the rectangle

► You cannot fire AIM-7 missiles when using TWS mode. You must designate the PDT or an SDT a second time and switch the radar to STT mode.

Use TWS mode with caution. The radar cannot actually track multiple targets while scanning a large volume of airspace. Instead, the radar scans each target, predicts where the target will move to, searches a wider pattern, and then returns to scan the predicted position of each target. As long as the target flies a relatively consistent course, this system works fine; however, if the contact makes a sudden, aggressive course change, the radar will continue to show the predicted course until it completes enough of the scan cycle to realize it has lost contact with the target. The target may move a considerable distance unseen while the VSD continues to display the erroneous position.

TWS is a powerful mode and necessary in order to fire multiple AIM-120 missiles at multiple targets. However, keep in mind its limitations and use it in conjunction with RWS and TWS modes.

4.104 Home On Jam (HOJ) Mode

If the radar detects a jamming signal, it displays a series of hollow rectangles along the bearing to the jammer on the VSD. If using AIM-7 or AIM-120 missiles, you may select and designate one of the Angle Of Jam (AOJ) rectangles. A vertical line appears through the AOJ markers and the VSD will display "HOJ" along the upper edge. Any AIM-7 or AIM-120 missiles will fly down the bearing of the jammer, attempting to locate the source.

► The AOJ markers only indicate the bearing to the jammer. It does not indicate the target's speed, altitude, heading, or range.

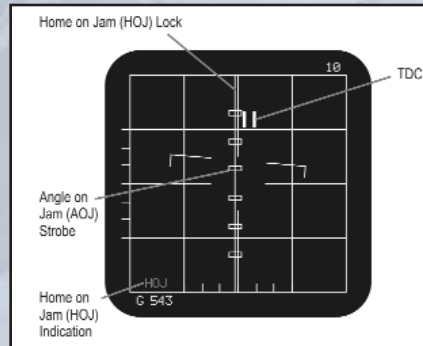

HOJ display

As you close on the jammer, eventually the reflections from your radar will be more powerful than the signals from the enemy's jammer. This is called burn through and indicates your radar is powerful enough to overcome the jamming. Once you reach burn-through range, the contact will appear on the VSD, replacing the AOJ marks.

4.105 Vertical Search (VS) Auto-Acquisition Mode

Vertical Search mode searches a fixed scan pattern 7.5° wide, ranging from 5° below the aircraft to 55° above. Range is fixed at 10 nautical miles. It automatically locks onto the target with the largest RCS within that pattern. After locking a target, the radar switches to STT mode.

This mode is particularly useful during a close-range, turning fight when you're stuck in lag and can't quite bring your aircraft's nose onto the target. This mode scans a pattern along your lift vector, helping you acquire targets up to 55° off-boresight.

The VSD shows no useful targeting information in this mode. Refer to the Vertical Search HUD mode for additional information.

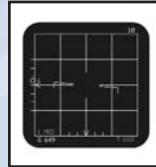

VS Auto-Acquisition Mode

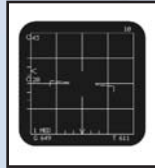

BORE Auto-Acquisition Mode

4.106 Boresight (BORE) Auto-Acquisition Mode

BORE mode works nearly identically to VS mode, but utilizes a smaller scan pattern aligned along the aircraft's longitudinal axis. The pattern is only 2° wide and 2 bars tall. As with VS mode, the HUD displays the significant targeting information, not the VSD. The radar locks the target with the greatest RCS within the BORE pattern and switches to STT mode.

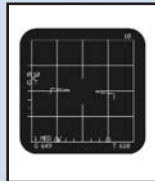

Guns Auto-Acquisition Mode

4.107 Gun Auto-Acquisition Mode

Gun mode is used in close-range dogfights. Gun mode engages the cannon and selects a fixed scan pattern, 60° wide and 20° tall. The range is set to 10 nautical miles. As with VS and BORE modes, the HUD shows the relevant information, not the VSD. The radar locks the target within the pattern with the greatest RCS and switches to STT mode.

4.108 FLOOD Mode

FLOOD mode is a close-range, visual dogfight mode used in conjunction with AIM-7 missiles. The radar emits energy in a continuous, 16° wide, 40° tall pattern. The azimuth and elevation indicators appear, as described for RWS mode, but the antenna position carets do not move. The range indicator is fixed at 10 nautical miles. The word FLOOD appears above the VSD.

► In FLOOD mode, all useful targeting information appears on the HUD, not the VSD.

This mode does not display contacts, nor allow lock on. It "floods" the vicinity with radar waves. Any AIM-7 missile launched in FLOOD mode will track the target with the greatest RCS within the flood pattern. If the target moves outside of the HUD's reference circle for more than 2 seconds, the missile loses lock and goes ballistic.

4.2. A-10A Maverick Seekers

The A-10A carries no radar or detection system other than the seeker heads in the AGM-65 Maverick missiles. The A-10A carries two versions of the Maverick, the television-guided AGM-65B and the Imaging Infrared (IIR) guided AGM-65K.

The AGM-65K and AGM-65D use the same procedure to attack a target. The first

step is to designate the point on the ground near which your desired target is located. Press the TAB key to stabilize the Mavericks seeker on this point in pitch and yaw. Once stabilized, you can move the center of the pointing cross above your desired target. Once the target is in range, the seeker will automatically lock on to the target and follow it. You can launch the missile at this time.

The only difference between the two versions of the Maverick is that the AGM-65K is optically guided with no magnification level and the AGM-65D is infrared-guided and has an optional 6X magnification level in addition to the default 3X.

The view from the seeker head appears on the TV monitor located on the right side of the instrument panel. The monitor shows the view with either no magnification or 4x zoom. The unmagnified view includes Narrow Field of View brackets. The brackets show the field of view visible in the monitor when zoomed to 4x magnification.

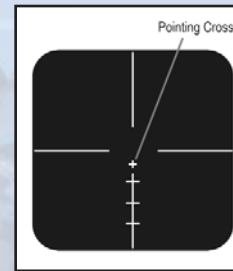

Typical AGM-65B View

The pointing cross moves within the monitor, indicating where the missile seeker is looking relative to the aircraft centerline. For example, if the pointing cross is above and to the right of the center of the monitor, the missile is looking above and to the right of the aircraft's nose. The AGM-65 can acquire 60° off boresight, but launch constraints require the missile be within +/- 30° off boresight.

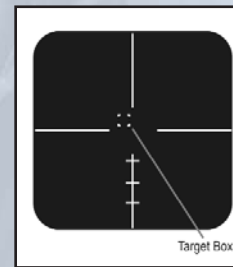

AGM-65B with Tracking Gate

RADAR WARNING RECEIVERS

Aircraft, ships, and ground stations broadcast radar signals everywhere searching for adversaries. Naturally, modern combat aircraft carry receivers designed to detect these emissions and warn pilots. Although Eastern and Western aircraft designers take slightly different approaches to the common problem, all radar warning receivers (RWRs) share some common aspects.

First, RWR equipment is passive, meaning it emits no signals of its own. It "listens" for the emissions from other transmitters, indicating the type of transmitter, the bearing to the transmitter, and if the emitter has locked onto the aircraft. RWR gear, however, does not indicate the range to the emitter.

► RWR equipment does not indicate the range to the transmitter.

5.1 U.S. Aircraft

The A-10 and F-15 radar warning receivers look slightly different, but operate virtually the same. In either aircraft, the center of the RWR represents your aircraft. The circular display represents the bearing around the plane; the top of the display indicates bearing 0 (directly ahead) while the bottom denotes bearing 180 (directly behind). The position of icons around the circle, therefore, indicates the bearing to the emitter.



F-15 Radar Warning Receiver



A-10 Radar Warning Receiver

The screen presents icons in two rings. The rings indicate the relative threat presented by the radar sources, but do not indicate the range to the emitters. The outer ring shows radars in search mode; the inner ring displays radars that have locked onto your aircraft. A tone also sounds, providing an audible alarm when radar locks onto your aircraft. Icons representing incoming radar-guided missiles will flash.

In the A-10, search and launch warnings are also indicated on the warning panel. Radar emitters are abundant on the modern battlefield. The RWR equipment can quickly become confusing, distracting, and even overwhelming as it displays the wide variety of contacts it detects. Consequently, the RWR supports three "declutter" levels:

- **Show All:** Shows all detected radar sources.
- **Show Only Lock:** Shows only radars locked onto your aircraft.
- **Show Only Launch:** Shows only radar-guided missiles tracking your aircraft.

Each icon on the RWR display consists of two components: the radar category and the emitter type. Radars come in five general categories:

- EW** • **Early Warning Radars:** The EW icon appears on the screen indicating the bearing to the radar emitter. The scope displays EW regardless of the emitter type (1L13 or 55G6 Russian EWR stations).
- ^29** • **Airborne Radars:** All airborne radars carry the ^ character above the emitter type, including AWACS and fighter radars.
- 12** • **Ground-Based Radars:** Icons for all ground-based radars, including SAM and AAA sites, appear within a box.
- SM** • **Ship-Based Radars:** Radar emitters mounted on ships appear with a bracket beneath the emitter type.
- 54** • **Active Missiles:** Icons for radar-guided missiles with onboard emitters appear within a diamond.

Symbols coupled with the radar category indicate the platform carrying the radar system. The following tables indicate symbols used for airborne, naval, land-based, and missile guidance radars.

Airborne Radar Symbology

Aircraft	RWR Icon
MiG-23ML	23
MiG-29	29
MiG-29K	29
MiG-31	31
Su-27	27
Su-30	30
Su-33	33
F-4E	F4
F-14A	14
F-15C	15
F-16C	16
F/A-18C	18
A-50	50
E-2C	E2
E-3A	E3

Active Radar-Guided Missiles

Missile	RWR Icon
R-33 (AA-9)	9
R-77 (AA-12)	12
AIM-54	54
AIM-120	AM

78 Radar Warning Receivers

Radar Warning Receivers 79

Ship-Based Radars

Ship Class	Radar System	RWR Icon
Azov (Kara)	SA-6	6
Albatross (Grisha-5)	SA-8	8
Grozny (Kynnda)	SA-3	3
Kuznetsov	SA-15	15
Kuznetsov	2S6	S6
Vinson	Sea Sparrow	SS
Moscow (Slava)	SA-10	10
Moscow (Slava)	SA-8	8
Nanuchka	SA-8	8
Neustrashimy	SA-15	15
Neustrashimy	2S6	S6
Oliver H. Perry	Standard Missile	SM
Orel (Krivak-3)	SA-8	8
Rezky (Krivak-2)	SA-8	8
Skory (Kashin)	SA-3	3
Spruance	Sea Sparrow	SS
Ticonderoga	Standard Missile	SM

Ground-Based Radars

Radar	NATO Codename	RWR Icon
S-300PS 40B6M tr	SA-10	10
S-300PS 40B6MD sr	SA-10 Clam Shell	CS
S-300PS 5H63C tr	SA-10	10
S-300PS 64H6E sr	SA-10 Big Bird	BB
S-300V 9532 tr	SA-12	12
S-300V 9S15MT sr	SA-12 Bill Board	BD
S-300V 9A82 in	SA-12	12
S-300V 9A83in	SA-12	12
Buk 9S18M1 sr	SA-11 Snow Drift	SD
Buk 9A310M1 in	SA-11	11
Kub 1S91	SA-6	6
Osa 9A22	SA-8	8
Strela-10 9A33	SA-13	13
Dog Ear Radar	Dog Ear	DE
Tor 9A331	SA-15	15
Tunguska	2S6	S6
Shilka ZSU-23-4	ZSU-34-4	23
Roland ADS	Roland	RO
Roland Radar	Giraffe	GR
Patriot str	Patriot	P
Gepard	Gepard	GP
Hawk sr	I-HAWK PAR	HA
Hawk tr	I-HAWK HPI	HA
Vulcan	M-163	VU
Zu-23	Zu-23	AA

5.2 Russian Aircraft

Emergency Procedures

Onboard warning systems call your attention to battle damage, system malfunctions, enemy threats, or other dangerous situations. Correct interpretation of warning signals may save your aircraft, or at least save your life by providing sufficient time to eject.

Master Warning System

The Master Warning System (MSW) is designed to attract your attention to a specific failure. A Master Warning Light will flash and an alarm tone will draw your attention to the instrument panel.

The MWS indicates that one of the following has occurred:

Master Warning Light



Missile Launch Warning

- **Impact with the ground is imminent** – Accompanied by an “X” symbol on the HUD, your current flight path will result in a collision. The light flashes at 1 Hz and emits an audible alarm. Pull up immediately.
- **Low fuel** – The MWS light flashes at 1 Hz and is accompanied by an alarm beep for 10 seconds. The red NJGKBDJ light on the fuel gauge also illuminates. Land as soon as possible.
- **Landing gear is still deployed at a high airspeed** – The warning light flashes at 1Hz and is accompanied by a warning beep. Both alarms cease when you retract the landing gear.
- **Some onboard equipment has failed or taken battle damage** – Check the instrument panel for individual warnings or failure indicators, such as a failed engine, failed hydraulic system, or malfunctioning radar. See later sections for more information on handling specific failures.
- **Your aircraft is being painted by enemy radar** – The MWS flashes at 5 Hz when the RWS detects enemy emissions. Flashing changes to 1 Hz when a lock-on has been detected. Check the threat warning display in the lower right corner of the instrument panel. Take evasive action as appropriate.
- **The Missile Launch Warning System has detected an inbound missile** – The MWS light is accompanied by the Missile Launch Warning light. Take evasive action immediately.

To reset the MWS, press the Shift + M key.

Radar Warning System

The SPO-15 “Beryoza” Radar Warning System (RWS) detects enemy radar signals and operates like any radar detector used in automobiles to locate police radar. Thanks to a more complicated antenna system (fitted in the tailcone) and more

80 Radar Warning Receivers

Radar Warning Receivers 81

processing power, the RWS not only detects radar, but also indicates the bearing to the transmitter and the type of radar detected. A totally passive system, it merely listens for other's emissions. This system is used in a variety of Russian aircraft including the MiG-29 Fulcrum, MiG-31 Foxhound, and Mi24P Hind.

The ten lights surrounding the MiG-21 picture illuminate to indicate the bearing to the transmitter. A flashing light indicates your aircraft is being painted occasionally by the emitter. A solid light indicates that a transmitter is tracking your aircraft. A red light surrounding the silhouette indicates a lock onto your aircraft. The six lights along the bottom of the RWS correspond, from left to right, to five categories of radar signals:

- Airborne radar
- Short-ranged SAM
- Medium-ranged SAM
- Long-ranged SAM
- Early warning radar
- AWACS

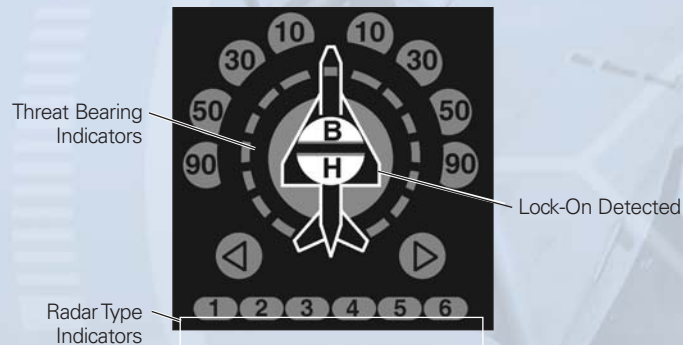

All Russian aircraft are equipped with an Identification Friend or Foe (IFF) system, allowing the RWS to distinguish between friendly and hostile radar sources. This system also replies to friendly emitters, alerting them that you're not a hostile target.

Missile Launch Warning System

The infrared MLWS detects the hot emissions produced by incoming missiles. A totally passive system, it watches for the type of heat produced by solid-propellant rocket motors. Its effective range varies depending on the intensity of the heat emission, but can generally spot inbound missiles up to 15 km away.

When the MLWS detects an inbound missile, the GEGR symbol (meaning "launch" in Russian) illuminates and produces a warning beep at 2 Hz for five seconds. The MLS light also illuminates. After five seconds the audio alarm silences, but the warning light remains on until the system loses contact with the missile.

► When the MLWS illuminates, take evasive action immediately!

The voice messaging system also provides audible cues indicating where the missile is coming from. The system will announce "Missile at..." followed by a clock position such as "12 high" or "6 low."

AIR-TO-AIR MISSILES

Like aircraft, missiles must obey the laws of physics and have very specific flight envelopes. When fired within the appropriate parameters, missiles have a deadly performance advantage over aircraft. When fired in marginal situations, however, the missile's chances of success go down dramatically.

Kinematic Range Against Non-Maneuvering Targets

Like aircraft, a missile's biggest problem is thrust. Missiles have a very limited amount of space for onboard fuel. Consequently, a missile's engine burns for a very short time (just a few seconds in some cases) and quickly accelerates the missile to maximum speed. The motor then burns out and the missile relies on its rapidly decaying momentum to reach the target. As with aircraft, the missile's turn performance is dependent upon how many g's it can pull. The slower the missile is, the less g's it can pull. The maximum range at which the missile is effective against a non-maneuvering target is called its kinematic range. As we'll see later, however, "range" is a very elusive topic.

Target aspect angle has a large impact on the missile's effective range. As shown in the figure below, a target heading directly at the missile covers part of the range. The shooter can fire the missile earlier since the target flies toward the missile, shortening the missile's time of flight. Conversely, a tail aspect greatly reduces missile range since the target is running away from the missile. Suppose the missile is fired at a target 10 km away. It takes the missile several seconds to travel that distance. By the time the missile has flown 10 km, the target may have moved another one or two kilometers further away. Missiles are substantially faster than aircraft, but run out of fuel much faster as well.



Effects of Head and Tail Aspect Angles on Missile Kinematic Range

The left-hand illustration in the figure on the facing page shows a typical envelope for a missile fired at a non-maneuvering target (in the center of the diagram). The gray zone represents the ranges from which the missile may be fired based on aspect angle. Notice that when fired head-on, the range is significantly longer than when fired from behind. The white area around the target defines the minimum range requirements for the missile. Since directly hitting the target is unlikely, most missile warheads are designed to emit some form of shrapnel in order to damage nearby aircraft. To prevent the launching aircraft from being inadvertently damaged by the missile explosion, the missile does not arm until it has flown a safe distance from the shooter. Also, the missile seeker or guidance system may require some amount of time to engage the target. The distance the missile must fly is known as the minimum range.

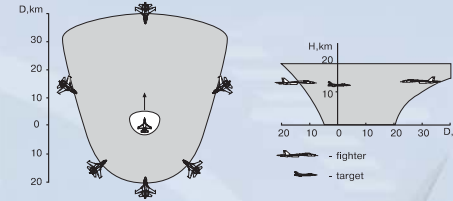

Typical Missile Envelope Against a Co-altitude, Non-maneuvering Target

Notice the right-hand illustration in the figure above. This shows the second major factor in missile range: altitude. Generally speaking, a missile's kinematic range doubles for each 6,100 m (20,000 ft) that altitude is increased. For example, if the missile's kinematic range is 20 km at sea level, it will double to approximately 40 km when fired at a co-altitude target 6,100 m higher. At 12,200 m (approximately 40,000 ft), missile range would increase to 80 km. When fired at a higher or lower target, the missile's range is generally associated with the median altitude between the shooter and the target (assuming the missile can climb high enough when fired at a higher altitude target).

Finally, the speed of the launching aircraft greatly impacts missile kinematic range. The slower the launcher is moving, the longer the missile will take to reach maximum speed. More of its limited motor burn will be spent accelerating to cruise speed. If the missile is launched at a higher speed, it will reach cruise speed and altitude faster, saving more of the motor burn for the "cruise" portion of the flight. Likewise, the speed of the target impacts the missile range as well. The faster the target is moving, the more distance it will cover during the missile's time of flight. In a tail-chase scenario, the target may escape the missile's maximum range. In a head-on scenario, the target may close inside the missile's minimum range!

Maneuvering Targets and Missile Evasion

Unfortunately, target aircraft rarely cooperate with your plans and often attempt to evade your missiles. So far, we have not discussed how target maneuvering affects missile performance. When fired at a maneuvering target, the missile will follow a curved trajectory to the target. This increases drag, bleeds speed, and reduces the missile's effective range.

The target may attempt to "drag" the missile; in this case the target executes a high-g turn until it facing directly away from the missile, then unloads to 1 g and accelerates directly away from the incoming missile. In this case, the target is attempting to place the missile in the shorter "tail aspect" portion of its flight envelope. Success depends primarily on how quickly the target can turn (a light fighter may execute an 8 g or 9 g turn; a heavily laden attack aircraft may be limited to 5 g or 6 g) and how quickly it can accelerate after bleeding speed away in that turn. Modern, more-capable missiles may have a no-escape zone; that is, at a given range (say 10 km), no aircraft in the world can turn fast enough and accelerate fast enough to escape. That same missile, though, may be unable to catch an aircraft performing a 6.5 g drag turn 25 km away.

The target may also attempt to "beam" the missile by turning toward the missile to place the inbound missile at either the 3 o'clock or 9 o'clock position, then maintaining a sufficient turn to keep the missile there. This forces the missile to

84 Air-to-Air Missiles

execute a continuous turn, bleeding speed and energy all the while. The target may also turn away to place the missile at the beam position as well. In any event, the target is trying to make the missile expend as much energy as possible, which shortens its range and its maneuverability.

Conclusion

From this we see that “missile range” is a very complex topic. Merely knowing that a missile has a 30 km range doesn’t do much good... When fired from what altitude? When the target is at what altitude? Against what aspect angle? At what airspeed? Overall, we can draw two main conclusions:

1. The closer you are to the target when you shoot, the better the chances that your missile will hit the target. Missiles fired at or near their maximum range (for the given circumstances) are not very likely to hit.
2. Launching from higher airspeed and altitudes significantly increases the missile’s effective range.

Missile Guidance

The missile’s guidance systems provide input to the missile’s control system, which in turn maneuvers the missile to intercept the target. Most modern AAMs are based on homing guidance. When homing, the guidance law is formed in the missile’s computer using information on target motion. There are three types of homing: passive, semi-active, and active.

The simplest of these types, passive homing, relies on emissions given off by the target itself (radio, heat, light, sound). In case of active and semi-active homing, the target is illuminated (usually by radar or laser), and the homing system guides on the illumination energy reflected off the target. For active homing guidance, the missile itself illuminates and tracks the target. Semi-active homing implies that some source external to the missile (for example, the radar of the launching platform) illuminates the target.

Some missiles, especially long-range ones, use combined guidance: inertial radio-corrected guidance and homing on the terminal part of flight. To implement inertial guidance, the launching aircraft computer feeds into the missile’s control system information on target coordinates, trajectory, and relative speed.

After the missile has started, its guidance system uses the information about the relative position of the missile and the interception point computed by the navigation system. During the flight of the missile, the interception point may significantly change. For this reason, radio correction supplements the inertial guidance. This increases the accuracy with which the missile reaches the target area. Upon approaching the target, the guidance system switches to homing, passive or active.

To home, a missile needs a device that will receive radiation from a target (sense it) and track the target. This device, known as a seeker, is located in the nose of the missile. However, semi-active homers may include a rear receiver for reception of information from the illuminating platform. Active homers contain a transmitter and receiver generally located forward. Depending on the type of radiation received by the missile, the seeker may use infrared or radar.

Air-to-Air Missiles 85

Passive Homing

Most seekers with passive homing are infrared (IR) seekers reacting to heat-radiating objects. This device contains a material sensitive to heat (IR radiation) that is produced primarily by the target’s propulsion system. The detector is often cryogenically cooled to eliminate internally generated temperature and allow detection of even very small amounts of IR energy coming from an external source.

► Passive seekers have an inherent advantage in their maximum range because their received power is inversely proportional to the square of the target range. The maximum range of active and semi-active systems varies inversely with the fourth power of the transmitter strength.

The range at which an IR seeker can see a target depends on the intensity of IR-radiation emitted by the target in the direction of the sensor and the seeker sensitivity. Therefore, the track range of the IR seeker depends very much on the engine operating mode of the aircraft being tracked and on the aspect angle, reaching its maximum value for attacks in the rear quarter.

The figure below presents a diagram of the IR-radiation intensity by a single-engined aircraft in the horizontal plane.

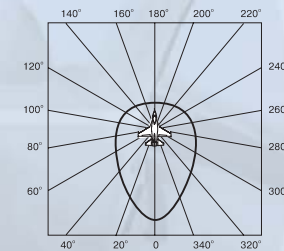

IR Radiation Intensity

After the launch, a missile using passive homing becomes completely autonomous and is known as “fire-and-forget.” If an IR seeker provides tracking of a target at any aspect angle, the seeker is said to be all-aspect; otherwise it is a rear-aspect seeker.

One of the major drawbacks of passive homing is its dependence on a “cooperative” target that continues to emit the energy required for homing. Besides, IR energy is absorbed and dissipated by water vapor, making heat seekers all but useless in clouds or rain. Discrimination between the target and background radiation generated by the sun or reflections off water, snow, clouds, and hot terrain such as deserts, can also be a problem for IR seekers.

Semi-active and Active Homing

For semi-active and active homing, a missile uses a radar seeker head. Radar-guided missiles are currently the most widely used all-weather AAMs. Here the power of radio emissions from a target and the sensitivity of the receiver determine the missile’s ability to track the target. As this case involves reflected radiation, its intensity depends on the power of the illuminating source and on

88 Air-to-Air Missiles

ahead of the warhead detonation point.

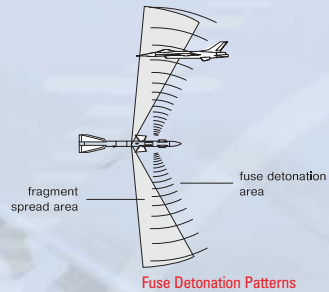

Note that modern AAMs contain a self-destruct mechanism in case the missile loses lock or control.

The pilot selects a particular type of missile depending on distance to the target and its maneuverability. Considering these characteristics, AA missiles can be divided into long-range, medium-range, and close air combat missiles.

6.1. NATO Air-to-Air Weapons

6.101 AIM-120 AMRAAM

The AIM-120 is the most effective, versatile air-to-air missile in service with Western forces. It has the greatest range, widest performance envelope, and the most capable guidance mechanism of any radar-guided missile in the West.

The launching F-15 must obtain a radar lock in STT or TWS radar modes. The radar sets a "fly out" point for the missile. When launched, the missile uses inertial guidance to fly to that point, where it activates its onboard radar and searches for the target. As long as the F-15 maintains a radar lock, it updates the "fly out" point to ensure the target is visible when the missile goes active. The radar relays the updated coordinates to the missile via a secure data link.

If the radar loses lock, it stops transmitting guidance instructions to the missile. In this case, the missile continues to the last coordinates it received and activates the onboard radar. It will engage the target with the largest radar cross-section it finds within its search pattern.

See the "HUD" chapter for details on targeting and firing the AIM-120.

AIM-120

Type: Medium-range, radar-guided, air-to-air missile

Weight, kg: 157

Length, m: 3.65

Body Diameter, m: 0.178

TNT Equivalent, kg: 22

Guidance: Command, inertial, and active radar

G Limit: 22

Maximum Mach Number: 3

Range, km: 50

Aircraft Types

1. F-15C

Target Acquisition Modes

1. STT mode with locked target
2. TWS mode with one or more designated targets

6.102 AIM-7 Sparrow

The Semi-Active Radar Homing (SARH) AIM-7 Sparrow served as NATO's primary Beyond Visual Range (BVR) missile for over two decades. The missile performed rather poorly in the skies over Vietnam, but improved versions accounted for the majority of air-to-air kills scored by the U.S.A. during the 1991 Gulf War.

The Sparrow does not carry a radar emitter. The launching aircraft must maintain a radar lock on the target, allowing the missile to home in on the radar waves reflected by the target. If the launching platform loses lock, the missile can no longer see the target and goes ballistic.

Alternatively, in dogfight situations, the F-15's FLOOD radar mode paints a broad radar pattern. Although it does not lock the target, AIM-7 missiles can still home in on the radar energy reflected by targets within the scan pattern. In FLOOD mode, the AIM-7 will track the target with the greatest radar cross-section up to 10 knots away.

See Chapter 3 for details on targeting and firing the AIM-7.

AIM-7

Type: Medium-range, radar-guided, air-to-air missile

Weight, kg: 230

Length, m: 3.66

Body Diameter, m: 0.203

TNT Equivalent, kg: 39

Guidance: Semi-active radar

G Limit: 20

Maximum Mach Number: 3

Range, km: 45

Aircraft Types

1. F-15C

Target Acquisition Modes

1. STT mode with a locked target
2. FLOOD mode with targets within 10 nm

Air-to-Air Missiles 89

90 Air-to-Air Missiles

Air-to-Air Missiles 91

6.103 AIM-9 Sidewinder

The heat-seeking AIM-9 Sidewinder has been NATO's workhorse missile for decades, but has begun to show its age. Although a potent all-aspect missile, it lacks the high off-boresight capability and maneuverability of the Russian R-73 (AA-11 Archer).

The AIM-9 locks targets through two methods. First, an F-15C can fire AIM-9 missiles at radar-locked targets in STT mode. Secondly, either an A-10A or an F-15C can use the missile's onboard seeker to track targets prior to firing the missile. In boresight mode, the missile seeker monitors a narrow area directly ahead. Uncaging the seeker lets the missile seeker head move in a search pattern, giving the missile a wider view of the airspace ahead. In either case, when the missile detects a heat source, it emits a tone. The tone increases in pitch as the missile gains a stronger track.

Heat-seeking missiles do not emit any signals and are therefore very difficult to detect. Unlike radar-guided missiles, enemy aircraft generally receive no warning of approaching heat-seeking missiles.

See Chapter 3 for details on targeting and firing the AIM-9.

AIM-9

Type: Short-range, infrared, air-to-air missile

Weight, kg: 85.5

Length, m: 2.87

Body Diameter, m: 0.127

TNT Equivalent, kg: 20

Guidance: Infrared

G Limit: 22

Maximum Mach Number: 2.5

Range, km: 8

Aircraft Types

1. A-10A
2. F-15C

Target Acquisition Modes

1. F-15C STT mode with a locked target
2. F-15C / A-10A seeker boresight (no radar)
3. F-15C / A-10A seeker uncaged (no radar)

6.2. Russian Air-to-Air Weapons

The GSh-301 Cannon

The gun is the most basic of air combat weapons. Although many believed the advent of air-to-air guided missiles would make the gun obsolete, repeated experience has shown that the gun remains an integral part of an aircraft's weapons package. The Flanker carries 150 rounds of 30mm ammunition capable of inflicting serious damage on an enemy aircraft. Activate the cannon mode by

pressing the C key from any air-to-air mode or while in air-to-ground mode.

Using Radar or Electro-Optical System (EOS) Targeting

Fortunately, the radar and EOS simplify the task of aerial gunnery by accurately measuring the range to the target and providing helpful cues on the HUD. Locking a target in Close Air Combat or Helmet Mounted Sight modes greatly improves the chances of hitting the target.

Once the target has been locked, extra cues appear on the HUD. The left side of the HUD shows the "Autotrack" cue (indicating the system is operational and tracking a target) along with a vertical range bar. The range bar provides three types of information at once:

1. **Range to target** – The arrow symbol along the right side of the range bar indicates how far away the target is. The marks along the left side of the bar help estimate the distance.
2. **Effective cannon range** – The marks along the right side of the bar indicate the cannon's maximum and minimum firing ranges.
3. **Aspect angle** – The pointed arrow affixed to the bottom of the range bar shows the target's heading relative to yours. If the arrow points straight up, you're directly behind the target. If the arrow points straight down, the target is heading directly at you.



The Autotrack HUD Symbology (Range > 1400 m)

As usual when locking a target, the target's airspeed and altitude are displayed above your own. The number of cannon rounds remaining is displayed in the lower right corner of the HUD. The aiming reticle is superimposed over the target as long as you maintain the lock.

► In general, steer your aircraft to keep the aiming reticle near the center of the HUD; this prevents the target from breaking the lock with a sudden maneuver.

As you close inside 1,400 m, the symbology changes. The range bar disappears and aiming crosshairs, also called "pipper," appear. The circle around the aiming crosshairs now represents the range to the target; the arc of the circle recedes counterclockwise as you get closer. The smaller the arc, the closer you are to the target. A full circle indicates the target is 1400 meters away.

To shoot the target, maneuver the pipper over the aiming reticle. When the computer calculates that you're in range, the Shoot Cue will appear. If you approach the target too closely, the HUD may show the Reject Cue OTB.

If the target manages to break the tracking lock, the HUD switches to the standard gun funnel mode. To re-establish the lock, disable the cannon by pressing C and repeat the target lock sequence using the radar.

92 Air-to-Air Missiles

Air-to-Air Missiles 93

Using the Cannon Funnel

In the event that the radar and EOS are unavailable or you are unable to achieve a lock, you can use the funnel display to manually aim the guns. The funnel appears whenever you enable the cannon (by pressing C) without having first acquired a lock. The funnel is designed to indicate the required amount of lead angle when firing at a fighter-sized target 200 m to 800 m away.

The funnel consists of two curved lines. The distance between the two lines represents a width of 15 m (the approximate wingspan of many fighter-sized targets) at varying ranges from 200 m (top of the funnel) to 800 m (bottom of the funnel). To use the funnel, bank your aircraft until the horizontal line in the middle is parallel to the target's wings (indicating you are in the same plane of maneuver as the target). Pull lead until the wingtips of the target just touch the two outer edges of the funnel. The further away the target is, the smaller its wingspan appears, so the further down the funnel you place it, thereby increasing the amount of lead you're pulling. Rounds fired now will impact the target.



The Gunner's Funnel

What happens if the target's wingspan is greater than (or less than) 15 m? The funnel specifically represents a wingspan of 15 m; against larger or smaller targets you'll have to estimate the difference. For example, a large target like a Tu-95 has a wingspan of roughly 50 m and will overlap the funnel. This figure compares an Su-27 and a Tu-95 700 m away:

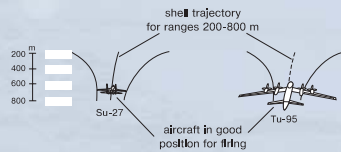

Comparing Target Wingspans with the Targeting Funnel

The following table shows the wingspans (minimum and maximum for variable-geometry aircraft) that you're likely to encounter. When engaging a target smaller or larger than 15 m, remember to adjust the funnel accordingly. If the target is smaller, don't pull as much lead. If the target is larger, pull more lead than indicated by the funnel.

Aircraft	Wingspan, m	Aircraft	Wingspan, m
MiG-23	7.8/14	Tu-22	23.6
MiG-27	7.8/14	Tu-95	50.05
MiG-29	11.36	Tu-142	51.1
MiG-31	13.46	Il-76	50.3
Su-24	10.36/17.63	A-50	50.3
Su-25	14.36	F-15	13.1
Su-27	14.72	F-16	9.4

Long-Range Missiles

R-33E / AA-9 Amos

The R-33E (USA/NATO designation: AA-9 Amos), designed by the Vympel OKB, is a long-range guided missile with an operating range up to 160 km. The missile employs inertial control and semi-active radar guidance on the terminal segment of flight. The R-33E is used to intercept aircraft and cruise missiles; that is why it is the principal missile of the MiG-31 Foxhound. The missile is capable of destroying targets ranging in altitude from 25 m to 28 km and flying at speeds up to Mach 3.5. Relative difference in altitudes of the missile and the target can be up to 10 km. The R-33E flies at Mach 4.5.

Medium-Range Missiles

R-23 / AA-7 Apex

The Vympel R-23 (AA-7 Apex) medium-range missile comes in two modifications with different seeker types. The R-23R (AA-7A) has a semi-active radar seeker while the R-23T (AA-7B) has an IR seeker. Both missiles have a maximum range of about 25–35 km. An older missile, the R-23 is often replaced by the more powerful and intelligent R-27 Alamo.

R-27 / AA-10 Alamo

AA-10 Alamo (see also AA-10; R-27; the Vympel R-27) is the primary medium-range AAM for the Su-27 and is available in several variants. The R-27 entered production in 1982 specifically for use on the new MiG-29 and Su-27 in place of the R-23 Apex used by the MiG-23. The R-27 is effective against highly maneuverable aircraft, helicopters, and cruise missiles. It can destroy targets at any aspect angle, both in daylight and at night, in good or bad weather. Its guidance system is resistant to natural interference and ECM, and capable of tracking targets against ground and water clutter. The R-27 can engage targets ranging in altitude from 25 m to 20 km with elevation up to 10 km. The targets can fly at speeds up to 3500 km/h and with g-load up to 8 g's.

The R-27 has a large number of versions equipped with various seeker heads. The basic semi-active radar homing (SARH) version is the R-27R (Alamo-A), often carried in conjunction with an R-27T (Alamo-B) IR-homing missile so that pairs of SARH and IR-homing missiles can be "ripple-fired" for improved kill probability. Long-range versions of both missiles have a new boost sustain motor and are externally recognizable by their increased body length and a slightly "fattened"

94 Air-to-Air Missiles

rear fuselage. These are designated R-27Re and R-27TE respectively. Two other variants are the R-27EM with an improved SARH seeker for better performance against low-flying and sea-skimming missiles, and the R-27AE with active radar terminal homing. The Su-27 standard warload includes six R-27s.

Version	Russian	Guidance	Maximum Range at High Altitude/Low Altitude, km
R-27R	P-27	Inertial radio-corrected guidance and semi-active radar terminal homing	80/10
R-27T	P-27	All-aspect passive infrared homing	72/10
R-27RE	P-27 Θ	The same as in R-27R	170/30
R-27TE	P-27 Θ	The same as in R-27T	120/15
R-27EM	P-27 MM	Inertial radio-corrected guidance and semi-active radar terminal homing (able to destroy cruise missiles at a height of 3 m above water surface)	120/20
R-27AE	P-27 AI	Inertial radio-corrected guidance and active radar terminal homing	120/20

R-77 / AA-12 Adder

The Vympel R-77 (AA-12 Adder) is a new-generation medium-range AAM. This missile is unofficially dubbed "AMRAAMski" in the West. The R-77 entered limited production in 1992 and is primarily intended for the new advanced versions of the Su-27 and MiG-29. The missile employs radio command guidance on the initial part of flight and active radar homing on approach to the target (15 km and less).

The R-77 can be effectively used against highly maneuverable aircraft, cruise missiles, AAMs and SAMs, strategic bombers, helicopters (including helicopters in hover mode). It can destroy targets moving in any direction and at any aspect angle, in daytime and at night, in good or bad weather. Its guidance system is resistant to ECM and is capable of tracking targets against ground and water clutter. Maximum operating range is 90 km. The missile can attack targets at aspect angles up to 90°. The R-77 has a maximum speed at high altitude of Mach 4.0.

Close Air Combat Missiles

R-60 / AA-8 Aphid

The R-60 (AA-8 Aphid) missile is a close air combat missile with all-aspect infrared passive homing. The maximum operating range is 10 km. The missile normally flies at Mach 2. The R-60 can be carried by practically any Russian combat aircraft and by many helicopters, though it is now considered obsolete and often replaced by the more intelligent R-73.

Air-to-Air Missiles 95

R-73 / AA-11 Archer

The Vympel R-73 (AA-11 Archer) was developed as a replacement for the R-60 and is the first of a new generation of highly maneuverable missiles for close air combat. The missile employs IR passive homing and has been described as being "a decade ahead of current Sidewinder" variants, and as the most sophisticated IR-guided AAM in service. The R-73 has a new level of agility and is capable of off-axis launch from all aspects. It has a very wide-angle sensor which can be slaved to the pilot's helmet-mounted sight, allowing the missile to be locked up at targets up to 60° from the aircraft axis. The missile can be launched from aircraft pulling up to 8.5 g's.

The R-73 employs aerodynamic control combined with vectored thrust. Tremendous maneuverability (up to 12 g's) is conferred by the missile's combination of forward-mounted canard fins, rudders on the fixed tailfins, and deflector vanes in the rocket nozzle.

The missile has a 7.4-kg expanding-rod warhead, and can destroy targets at altitudes of as low as 5 meters and at ranges up to 30 km. The R-73 normally flies at Mach 2.5.

The table below contains the comparative characteristics of various types of modern Russian AAMs. The maximum number of a specific type of weapon that can be carried is shown next to the aircraft designation in parentheses.

96 Air-to-Air Missiles

Air-to-Air Missiles 97

Type	Russian	USA/NATO	Carrier (#)	Weight, kg	Seeker	Range, km (Maximum range at high altitude)
R-23R	P-23P	AA-7A/Apex	MiG-23 (2)	223	SARH	35/25
R-23T	P-23T	AA-7B/ Apex	MiG-23 (2)	217	IR	35/25
R-27R	P-27P	AA-10A/Alamo-A	MiG-29 (4), Su-27 (6), Su-33	253	SARH	80
R-27T	P-27T	AA-10B/Alamo-B	MiG-29 (4), Su-27 (6), s Su-33	254	IR	72
R-27RE	P-27H	AA-10C/Alamo-C	MiG-29 (4), Su-27 (6), Su-33	350	SARH	170
R-27TE	P-27N	AA-10D/Alamo-D	MiG-29 (4), Su-27 (6), Su-33	343	IR	120
R-33A	P-33F	AA-9/Amos	MiG-31 (6)	490	SARH	160
R-60	P-60	AA-8/Aphid	Su-24 (2), Su-25 (2), MiG-23 (4), MiG-27 (2)	45	IR	10
R-73	P-73	AA-11/Archer	MiG-29 (6), MiG-31 (4), Su-24 (2), Su-25 (2), Su-27 (10), Su-33	110	IR	30
R-77	P-77	AA-12/Adder	MiG-29 (6), MiG-31 (4), Su-25 (2), Su-27 (10), Su-33	175	Radio command +ARH	90

AIR-TO-GROUND WEAPONS

Air-to-ground weapons come in two categories: guided and unguided. Guided weapons include air-to-ground missiles and laser-guided bombs. Unguided weapons include rockets and free-fall bombs.

Free-fall bombs, also called iron bombs, are the mainstay of air-to-ground weapons. Although modern guided weapons are substantially more accurate, such "smart" weapons are also substantially more expensive. Iron bombs, therefore, have remained in widespread service around the world for seven decades.

Iron bombs are not particularly accurate. They simply fall to the ground with no ability to maneuver or steer. The launching aircraft must fly a stable, consistent flight path when releasing the weapon. Banking the wings or making sudden pitch changes when releasing the weapon slings it off course. Wind can also push the bomb off course. Therefore, iron bombs should not be used in situations requiring high precision or minimal collateral damage.

► Sudden flight path changes when releasing iron bombs greatly reduces accuracy.

The effective range of an iron bomb depends primarily on two factors: the speed and the altitude of the releasing aircraft. Increasing speed and increasing altitude "throws" the bomb further. The following table illustrates the effect of airspeed and altitude on the effective range of a typical 500 lb iron bomb when released from straight-and-level flight.

Altitude (AGL)	Airspeed (kts)	Bomb Range (ft)
500	240	2100
500	400	3600
1000	240	3100
1000	400	5100
1500	240	3800
1500	400	6300
2000	240	4400
2000	400	7200
4000	240	6200
4000	400	10200

Iron bombs come in many sizes and shapes, ranging from 500 lbs to 2,000 lbs. Most "general purpose" bombs carry a single explosive warhead, while Cluster Bomb Units (CBUs) contain a canister of "bomblets" which are dispersed over a wide area.

► Iron bomb range is primarily determined by the speed and altitude of the releasing aircraft.

Rockets are widely used against "soft" targets, including trucks, lightly armored vehicles, and troop emplacements. Rockets are relatively difficult weapons to use. The slightest alteration to flight path during firing severely alters the rockets' course. Rockets have a tendency to "weather vane," or turn based on the wind.

► **Generally, fire rockets in volleys to saturate the target.**

Guided missiles and bombs are the most effective, but also the most expensive. Laser-guided, IR-guided, and television-guided weapons have amazing precision, able to strike a single tank within a column or strike a specific section of a building. Employment procedures and operational constraints vary depending upon the weapon type, but higher altitudes and faster airspeeds generally increase their effective range.

7.1. NATO Air-to-Ground Weapons

7.101 LAU-10 and LAU-61 Rockets

Rockets, because of their inherent inaccuracy and relatively limited firepower, see limited use in the U.S.A.F. Rockets have no guidance mechanisms, requiring visually aiming. Rockets are notoriously inaccurate; the slightest variation in flight path while firing rockets can substantially alter their flight path and reduce their accuracy. Wind is especially problematic. Gusting winds can push the rockets off course, and rockets have a propensity to “weather vane,” or turn into the wind.

Rockets are only effective against “soft” targets, such as trucks, lightly armored vehicles, and troop concentrations. Generally, rockets must be fired in large volleys to ensure target saturation. The LAU-10 canister carries four 5-inch rockets. The LAU-61 canister holds 19 smaller, 2.75-inch rockets.

See Chapter 3 for details on aiming rockets.

LAU-10 (Zuni)

Type: 127mm unguided rocket

Weight, kg: 56.3

Length, m: 2.93

Body Diameter, m: 0.127

TNT Equivalent, kg: 26

Speed Km/H: 2520

Range, km: 4

LAU-61 (Hydra)

Type: 70mm unguided rocket

Weight, kg: 6.2

Length, m: 1.06

Body Diameter, m: 0.070

TNT Equivalent, kg: 2.4

Speed Km/H: 4388

Range, km: 8.8

Aircraft Types

1. A-10A

7.102 Mk 82 and Mk 84 General-Purpose Bombs

The basic Mk 80 series of Low-Drag General-Purpose (LDGP) bombs, also called “iron bombs,” have been the mainstay of U.S.A.F. ground-attack aircraft for decades, and are carried by a wide variety of aircraft. The bombs are effective against a wide variety of targets, including trucks, bunkers, air defense sites, buildings, bridges, etc. The 500 lb Mk 82 and 2,000 lb Mk 84 have seen extensive action over the decades. 12,189 Mk 84 and 77,653 Mk 82 bombs were dropped during the 1991 Gulf War.

Being unguided, the pilot aims the weapon visually. With practice, a well-trained pilot can usually achieve a 400 ft Circular Error Probability (CEP), meaning half of the bombs dropped will land within 400 ft of the intended target. Although guided weapons greatly improve accuracy, they are significantly more expensive than unguided iron bombs, meaning the Mk 82 and Mk 84 are likely to remain in front-line service for many years to come.

The effective range of an iron bomb varies greatly depending upon the speed and altitude of the releasing aircraft. Flying higher and faster significantly increases the effective range.

See The “Heads-Up Display Mode” chapter for details on aiming iron bombs.

Mk-82

Type: General-purpose bomb

Weight, kg: 241

Length, m: 2.21

Body Diameter, m: 0.273

TNT Equivalent, kg: 89

Mk-84

Type: General-purpose bomb

Weight, kg: 894

Length, m: 3.84

Body Diameter, m: 0.46

TNT Equivalent, kg: 428

Aircraft Types

1. A-10A

7.103 AGM-65B and AMG-65K Maverick Missiles

The AGM-65B and AGM-65K Maverick missiles are highly accurate, very effective fire-and-forget missiles. With an effective range of about 10 nm (depending on the altitude and airspeed of the launching aircraft), the Maverick carries an 80 lb high-explosive, shaped-charge warhead and is very effective against armored vehicles. Targeting procedures are somewhat labor intensive, though, and can be difficult to employ in combat.

100 Air-to-Ground Weapons

The Maverick is one of the A-10A's most important weapons. Of the 5,255 Mavericks fired during the 1991 Gulf War, over 4,000 were fired from Warthogs. The AGM-65 is intended for use against armored vehicles, bunkers, boats, radar vans, and small "hard targets."

The AGM-65B carries an electro-optical (television) seeker limited to daylight and good weather conditions. The AGM-65K uses an Imaging Infrared (IIR) seeker, which detects heat emitted by the target. The IIR seeker can therefore be used at night or in hazy conditions. Neither missile receives any kind of guidance information from the aircraft after launch. The pilot is free to maneuver or engage another target as soon as the missile comes off the rail.

See the "Sensors" chapter for details on using AGM-65 missiles.

AGM-65B

Type: Short-range, TV-guided, air-to-surface missile

Weight, kg: 210

Length, m: 2.49

Body diameter, m: 0.305

TNT Equivalent, kg: 57

Guidance: TV

G Limit: 16

Maximum Mach Number: 0.85

Range, km: 27

AGM-65K

Type: Medium-range, infrared, air-to-surface missile

Weight, kg: 220

Length, m: 2.49

Body Diameter, m: 0.305

TNT Equivalent, kg: 57

Guidance: Imaging Infrared

G Limit: 16

Maximum Mach Number: 0.85

Range, km: 27

Aircraft Types

1. A-10A

7.104 Mk 20 Rockeye Cluster Bomb

The Mk 20 Rockeye is an unguided, free-fall cluster bomb containing 247 armor-piercing submunitions. The Rockeye releases the bomblets in a rectangular pattern and is highly effective against tanks, vehicles, and troop concentrations. The Rockeye is not effective against hardened structures, like bunkers or bridges. Nearly 28,000 Rockeyes were dropped during the 1991 Gulf War.

Air-to-Ground Weapons 101

Being an unguided iron bomb, the Mk 20 shares the employment constraints of other iron bombs: visual targeting reduces accuracy, and effective range is determined primarily by the speed and altitude of the releasing aircraft.

See Chapter 3 for details on aiming iron bombs.

Rockeye (Mk20)

Type: Multipurpose cluster bomb

Weight, kg: 222

Length, m: 2.34

Body Diameter, m: 0.335

TNT Equivalent, kg: 50

Aircraft Types

1. A-10A

7.105 ALQ-131

The Westinghouse ALQ-131 jamming pod began development in the early 1970's. It operates over a wide range of frequencies and utilizes a power management module to control the jammer's output power. With digital reprogrammable software, the ALQ-131 still provides effective jamming support on today's electronic battlefield.

7.2. Russian Air-to-Ground Weapons

Bombs

Bombs are used for destroying comparatively large and fortified targets. After the release the bomb either follows a ballistic trajectory (free-fall bombs), or moves under control of its guidance system (guided bombs).

A typical bomb consists of a cylindrical body equipped with stabilizers, a charge of explosive, and a fuse. The most common bombs are blast (Russian designation FAB), fragmentation (OAB), concrete-piercing (BetAB) and incendiary (ZAB) bombs, and combined-action bombs, (for example, blast-fragmentation (OFAB) bombs). All these types of bombs can be monolithic or cassette.

Free-Fall Bombs

Free-fall bombs have no guidance or control capabilities, falling along a relatively predictable path depending on the flight profile of the aircraft at the time of release.

102 Air-to-Ground Weapons

FAB-250, FAB-500, FAB-1500 General-Purpose Bombs

The FAB-250, FAB-500, FAB-1500 general purpose bombs contain charges of high explosive. FAB stands for Blast Aviation Bomb in Russian, and the number in the bomb designation denotes its caliber in kilograms: 250, 500, and 1500 kg, correspondingly. These bombs damage targets mainly by shock wave, and they are effective against defense facilities, industrial facilities, railway junctions, ships, and soft targets.

General-purpose bombs are the cheapest of all major air-to-ground munitions. For effective delivery, it is desirable to release general purpose bombs at a speed of 500-1000 km/h and at altitudes of 300-5000 m.

OFAB-250 Blast-Fragmentation Bomb

The OFAB-250 is a 250 kg blast-fragmentation bomb (OFAB stands for Blast Fragmentation Aviation Bomb in Russian) that combines the effects of both the general purpose and fragmentation bombs. The blast creates a cloud of small fragments and shrapnel. This weapon is effective against personnel and lightly armored vehicles. It is released at airspeeds from 500 to 1000 km/h and at altitudes from 500 to 5000 m using any delivery method.

PB-250 Retarded Bomb

The PB-250 is a 250 kg blast-fragmentation bomb fitted with a drogue chute deployed when the bomb is released. The parachute increases air resistance of the bomb and, consequently, greatly reduces its speed. This allows the pilot to bomb from low altitudes, since the aircraft will have enough time to leave the blast radius before the weapon detonates.

The bomb contains a blast-acting charge, the required fragmentation being provided by special design of the bomb casing. The PB-250 is effective against personnel, lightly armored vehicles, truck convoys, parked aircraft on airfields, etc. Delivery the weapon from low altitudes of 100-300 meters and at airspeeds of 500-1000 km/h.

BetAB-500ShP Concrete-Penetrating Bomb

The BetAB-500ShP concrete-penetrating bomb (BetAB stands for Concrete-Piercing Aviation Bomb in Russian) is a special-purpose bomb effective against reinforced concrete bunkers and runways. As opposed to a general-purpose bomb, the BetAB has a stronger frame and a hardened nose. Given sufficient kinetic energy, the bomb penetrates through the concrete and then explodes. The BetAB-500ShP is fitted with a drogue chute and a solid-propellant booster. The parachute initially slows the bomb down, giving the aircraft more time to clear the impact zone. The parachute is then released as the booster ignites, accelerating the bomb to the speed necessary to penetrate hardened concrete.

Deliver the weapon from altitudes of 150-500 m at airspeeds from 550 to 1100 km/h.

ZAB-500 Incendiary Bomb

The ZAB-500 is a 500 kg incendiary bomb (ZAB stands for Incendiary Aviation Bomb in Russian) used against enemy personnel, industrial facilities, railway stations, etc. Its casing is filled with a combustible mixture based on thickened petrochemicals. To spread viscous mixture and ignite it, the bomb uses a bursting charge and an igniting cartridge.

Air-to-Ground Weapons 103

RBK-500 Cluster Bomb

Cluster bomb dispensers are actually thin-walled casings containing small-sized fragmentation, antitank, incendiary, concrete-piercing bomblets. Each bomblet weighs up to 25 kg.

Release of the RBK-500 bomb (RBK stands for Expendable Bomb Cassette in Russian) arms a proximity fuse, which detonates within a preset time at a preset altitude. The casing breaks apart into two halves and ejects the bomblets in a dense cloud. The bomblets cover an area which depends on the speed and altitude at which the casing breaks apart. Thus, unlike a usual bomb, a cluster bomb destroys targets in a considerably wide area. Delivered at low altitude for maximum effect.

KMGU Cluster Bomb

Bomblets can also be dispensed from an aircraft-mounted, multipurpose nondrop pod (Russian designation KMGU stands for Unified Container of Small Loads) containing up to four compartments. The pilot can dispense submunitions from two compartments at a time or from all the compartments simultaneously. The submunitions should be dispensed in level flight at low altitudes (50-150 m) and at airspeeds of 500-900 km/h.

Guided Bombs

Guided bombs are among the most effective and "smart" types of air-to-ground weapons, combining high efficiency of target destruction with relatively low cost. This kind of weapon is effective against fixed ground targets (railway bridges, fortifications, communications, junctions) and is fitted with a blast or armor-piercing warhead.

Like air-to-ground missiles, guided bombs use TV, IR, and laser targeting techniques. As with missiles, weather and moisture degrade targeting capability.

KAB-500KR/L TV/IR-Guided Bomb

The KAB-500 guided blast bomb (KAB stands for Controlled Aviation Bomb in Russian) employs TV or IR homing. The TV-guided KAB-500KR is normally used in daytime in conditions of fair visibility, while the IR-guided KAB-500L is mostly applied at night and against camouflaged targets. The warhead can be either armor-piercing or blast. The TV seeker head includes a TV camera, a microprocessor, and a power supply unit. The angular field of vision of the TV seeker is equal to 2-3°. After lock onto a target and release, the bomb becomes completely autonomous. To correct its trajectory, the bomb uses control surfaces, which ensure accuracy of about 3-4 m.

The KAB-500 is normally delivered using a shallow dive-bombing technique. Typically, the pilot releases this bomb at airspeeds of 550-1100 km/h and at altitudes of 500-5000 m.

KAB-1500L Laser-Guided Bomb

Front-line and long-range aircraft often carry the powerful KAB-1500L laser-guided bomb. It is effective against super-hardened targets, hardened fortification installations, nuclear storage bunkers, strategic command centers, etc. The KAB-1500L employs semi-active laser homing with impact accuracy of about 1-2 m. The bomb is fitted with either a penetrating warhead (capable of penetrating up to 2 m of concrete), or an explosive warhead (which blasts a

104 Air-to-Ground Weapons

crater wider than 20 m in diameter). The pilot can employ the bomb at altitudes from 500 to 5000 m while flying at airspeeds of 550-1100 km/h.

The table below contains specification of some popular bombs:

Type	Carrier (#)	Weight, kg	Warhead weight, kg	Warhead Type
FAB-250, OFAB-250, PB-250	Su-33 (12), Su-24 (18), Su-25 (10), MiG-27 (8), MiG-29 (8), Tu-95 (60)	250	230	blast blast-fragm. blast-fragm.
FAB-500	Su-33 (6), Su-24 (8), Su-25 (8), MiG-27 (4), MiG-29 (4), Tu-95 (30)	500	450	blast
FAB-1500	MiG-27 (2), Tu-95 (18)	1400	1200	blast
BetAB-500 ShP	MiG-27 (2)	425	350	concrete-penetrating
ZAB-500	Su-33 (6), Su-24 (7), Su-25 (8), MiG-27 (4), MiG-29 (4)	500	480	incendiary
RBK-500	Su-33 (6), Su-24 (8), Su-25 (8), MiG-27 (4), MiG-29 (4)	380	290	cluster/fragm.
KAB-500	Su-33 (6), Su-24 (4), Su-25 (8), MiG-27 (2)	560	380	armor-piercing or blast
KAB-1500L	Su-24 (2), MiG-27 (1)	1500	1100	blast
KAB-1500 KR	Su-33			

Air-to-Ground Weapons 105

Unguided Rockets

Despite the existence of high-accuracy weapons, unguided rockets remain a powerful and flexible air-to-ground weapon, combining high combat efficiency and simplicity of use with low cost. An unguided rocket has a relatively simple design and consists of a fuse and a warhead in the nose part followed by the rocket body with a solid-propellant motor and stabilizer. Unguided rockets are usually placed in special rocket pods.

The rocket motor begins to operate at the moment of launch. Due to thrust provided by the motor, which usually operates from 0.7 to 1.1 seconds depending on the rocket type, the rocket accelerates to 2100–2800 km/h. After the motor burns out, the rocket coasts, gradually slowing down because of air resistance. Like a projectile, the unguided rocket follows a ballistic trajectory. To provide steady flight, a rocket has a stabilizer located in its tail part. It serves to align the longitudinal axis of the rocket with its velocity vector. As unguided rockets are usually carried in launching pods, the stabilizer fins are kept folded inside the launch tubes of the pod. When the pilot launches the rocket, the stabilizer fins flip out into a fixed position.

Some types of unguided rockets stabilize by spinning themselves about the longitudinal axis. To spin, a rocket can utilize specially shaped stabilizer fins (for small caliber rockets), or rifled nozzles in the launch tubes. Angular velocity of rotation ranges between 450 rpm and 1500 rpm and develops within a short interval after the launch.

Depending on combat tasks, the pilot can employ unguided rockets of different caliber (from 57mm up to 370mm in diameter), fitted with fuses and warheads of appropriate types. A fuse can detonate on hitting the target, as, for example, in the case of an armor-piercing warhead, or at a certain distance from the launching platform, as in the case of a flare warhead.

Hit accuracy is characterized by an effective range, which depends on the type of unguided rocket. Since a rocket flies without any guidance, its accuracy decreases as the distance to the target increases.

Each type of unguided rocket has a specific possible launch zone limited by effective launch range and by safety range. The safety range depends on the warhead type and weight and should prevent the launching aircraft from being damaged by the debris after the warhead explosion.

The pilot mostly employs unguided rockets at airspeeds of 600-1000 km/h while diving 10–30°. By maneuvering the aircraft, the pilot should line up on the target. Before the aircraft enters the rocket launch envelope, the pilot should place the aiming reticle on the target and, on entering the launch envelope, pull the trigger to launch.

S-8 Rocket

The S-8 is a medium-caliber, unguided rocket (80mm in diameter) placed into the twenty-canister B-8 rocket pod. The S-8 has an effective range of 2000 m. The margin of error is roughly 0.3% of launch range; rockets fired at a range of 2000 m hit within a circle of 6 m in diameter. The S-8 is normally deployed with a shaped-charge fragmentation warhead effective against soft targets. Armor-piercing (capable of penetrating 0.8m of reinforced concrete) and fragmentation warheads are also available.

106 Air-to-Ground Weapons

Air-to-Ground Weapons 107

S-13 Rocket

The S-13 is a 132mm, unguided rocket placed in the five-round B-13 rocket pod. It is effective against fortified installations and hardened facilities (fixed emplacements, bunkers, hardened aircraft shelters, and runways). These unguided rockets can be fitted with warheads of various types. The concrete-piercing warhead can penetrate 3 m of ground cover or 1 m of reinforced concrete. The S-13 has an effective range of 3000 m.

The S-13T variant carries a two-stage penetrating warhead which detonates inside the target after piercing the protective covering (up to 6 m of ground cover or up to 2 m of reinforced concrete). When the rocket hits a runway, it damages an area of about 20 square meters. The blast-fragmentation warhead of the S-13OF version produces about 450 fragments weighing 25–35 grams each, effective against lightly armored vehicles.

S-24 Rocket

The S-24 is a large-caliber (240mm), unguided rocket fitted with a powerful, solid-fuel rocket motor. The motor operates for 1.1 seconds, accelerating the rocket and providing a stabilizing spin. The S-24 rocket can be fitted with a blast fragmentation warhead containing 23.5 kg of high explosive. The body of the warhead is perforated and offers special induction hardening that provides very even fragmentation. After detonation, the body breaks up into 4000 fragments having an effective radius of 300–400 m.

The rocket is usually fitted with a proximity fuse, detonating over the target at an altitude of about 30 m. To destroy hardened targets, the S-24 may carry a delay-after-impact fuse. The warhead housed into a strong casing pierces the covering of the target and detonates inside.

S-25 Rocket

The S-25 is a super-heavy unguided rocket housed in an expendable container. Inside its container, the rocket's four stabilizer fins are folded between four skewed jet nozzles providing stabilization spin-up.

There are several versions of the S-25 rocket in service with varying warheads effective against different target types. The S-25-O, fitted with a fragmentation warhead and a radio-proximity fuse, is effective against personnel, transport, parked aircraft, and other soft targets. The S-25-OF, with a blast-fragmentation warhead, destroys lightly armored vehicles, buildings, and personnel. The S-25-OFM has a modernized, strengthened penetrating warhead, which is effective against hardened facilities and warehouses, shelters, and other protected targets. The S-25 has an effective range of 2000 m with a margin of error of about 0.3% of launch range (rockets fired at a maximum of 2000 m will land within a 6 m diameter).

The table below contains specification for various types of unguided rockets:

Type	Carrier (#)	Range, km	Weight, kg	Warhead type
S-8B	MiG-27 (80), MiG-29 (80), Su-24 (120), Su-25 (160), Su-33 (120)	2.2	15.2	concrete-piercing
S-13OF/S-13T	MiG-27 (20), MiG-29 (20), Su-24 (30), Su-25 (40), Su-33 (30)	2.5	68/67	blast-fragmentation/ penetrating
S-24B	MiG-27 (4), MiG-29 (4), Su-24 (4), Su-25 (8)	2	235	blast-fragmentation
S-25OF	Su-24 (6), Su-33 (6)	3	380	blast-fragmentation
S-25OFM	Su-24 (6), Su-33 (6)	3	480	penetrating

Cannon Strafing

The cannon is located in the starboard wing root extension and is normally used in conjunction with the laser rangefinder. The cannon is extremely accurate, having a fire rate of 1,500 rounds per minute, with 150 rounds ammunition. The barrel of the GSh-301 has a 2,000-round life, equivalent to 80 seconds of fire at usual 1500 rpm. The cannon is fixed in the forward direction.

During an attack on ground targets, the cannon and unguided rockets are employed in effectively the same way. The main differences are the maximum effective range and the minimum range (dictated by firing safety), which for GSh-301 are 1800 and 700 meters, respectively.

GROUND SCHOOL

Air combat is a complicated task; military pilots receive years of training and practice before being turned loose to fight for their country. Simulated air combat isn't as complicated, but a thorough understanding of basic flight and combat principals is required to ensure victory.

8.001 Indicated Airspeed and True Airspeed

All airspeeds are not created equal. Dense air at lower altitudes both increases the lift generated by the wings, and resists the aircraft's movement. Thinner air at higher altitudes reduces the amount of lift the wings can produce, but lets the aircraft move more easily. As a result, an aircraft moving at a constant 350 knots has different performance and flight characteristics at sea level than at 40,000 ft. This is called the aircraft's True Airspeed (TAS).

Most modern aircraft adjust the airspeed display to account for altitude. This Indicated Airspeed (IAS) displays the airspeed that would provide equivalent performance at sea level. For example, an aircraft flying at 350 knots IAS at 5,000 ft has the same performance as flying 350 knots IAS at 45,000 feet; however, its TAS is actually significantly faster at the higher altitude. Displaying IAS reduces the pilot's workload, minimizing the amount of flight performance data that must be memorized.

► **Some airspeed indicators show TAS; others show IAS. Always confirm the operation of each air speed indicator prior to takeoff.**

8.002 Velocity Vector

The velocity vector is an extremely important indicator displayed on most fighter jets' HUDs. The velocity vector shows where the aircraft's momentum is actually taking it. For example, any time you change course, the aircraft's momentum keeps it moving in the original direction until the thrust of the engines overcomes the momentum and establishes a new heading. Aircraft like the MiG-29 and Su-27 are famous for high AOA flight, in which case the aircraft's nose is pointing one direction, but the plane is actually moving a different direction. In this case, the velocity vector indicates where the aircraft is actually heading.

► **The velocity vector is useful during landings. If the velocity vector appears short of the runway, you're going to crash short of the runway!**

8.003 Angle Of Attack Indicator

Whenever the velocity vector is not aligned with the aircraft's heading, the pitch angle between the airflow and where the aircraft is pointing is called the Angle Of Attack (AOA). Anytime the pilot pitches the aircraft (whether in a steep turn, or just initiating a climb), the AOA increases. In level flight, reducing thrust generally increases AOA because the reduced thrust results in reduced lift. The aircraft begins to sink while holding a nose-level attitude.

AOA and airspeed impact the amount of lift (G-load) generated by the wings. Generally, if the wing isn't stalled, then increasing AOA will increase the amount of lift being generated. Likewise, increasing speed with a constant AOA also increases lift. Unfortunately, this also increases the drag generated by the wing,

therefore causing the aircraft to slow down. Slowing down subsequently reduces lift and drag, allowing the aircraft to accelerate again.

► **A stall can occur at any altitude, airspeed, or flight attitude.**

Increasing AOA eventually disrupts the airflow over the wing. This is called stalling the aircraft. During a stall, the reduced airflow over the wing severely decreases the amount of lift generated. A stall can occur at any altitude, airspeed, or flight attitude simply by increasing the AOA too much. A stall can have disastrous consequences during a dogfight, as explained below in the "Lift, Turn Rate, and Turn Radius" section. Learn to avoid stalling during a dogfight.

If the aircraft sideslips during a stall, the aircraft is likely to depart controlled flight. In most cases, this "departure" results in a spin, but some aircraft are prone to other types of rocking, pitching, and tumbling. During a departure, the pilot has no control over the aircraft and must focus on regaining controlled flight. To recover from a spin, reduce the throttle and apply rudder opposite to the direction of the spin. In most cases, pushing the control stick forward helps, also. Hold these flight controls until the aircraft stops spinning and responds to control inputs. It is common to lose several thousand feet of altitude during a spin.

► **To recover from a spin: Reduce throttle, apply rudder opposite to the direction of the spin. It often helps to push the control stick forward, also. Hold these controls until the aircraft stops spinning.**

8.004 Lift, Turn Rate, and Turn Radius

The lift vector (the direction of the g-load generated by the wings) is perpendicular to the wings. As long as lift equals gravity, the aircraft maintains a steady altitude. Banking the aircraft reduces the amount of lift directly opposing gravity.

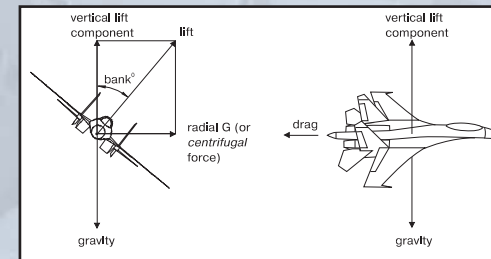

How Bank Angle Affects G-Load

Aircraft performance is generally described in terms of turn rate and turn radius, both of which are dependent upon the aircraft's speed and the amount of lift, or g-load, being produced. Turn rate measures the speed at which the nose is moving around the circle, typically measured in degrees per second. A high turn rate means the aircraft could complete a 360° turn very quickly. Turn radius, as the name implies, measures the size of the aircraft's turn. The ideal fighter couples a low turn radius with a high turn rate.

110 Ground School

Ground School 111

8.005 Corner Speed

Increasing g-load improves both turn rate and turn radius. Increasing airspeed degrades both turn rate and turn radius. Recall from the discussion above on AOA, though, that increasing speed increases g-load, leading to a catch-22 situation. The trick is to maintain the appropriate speed that maximizes turn performance, called the corner speed.

► **The corner speed produces the best combination of turn rate and turn radius.**

The corner speed produces the combination of the highest turn rate with the smallest turn circle. It may not necessarily be the absolute best turn rate or turn radius, but rather finds the point where the two attributes each have good values. Turning speed varies according to the aircraft, altitude, and drag from the external stores, but generally falls 300 to 400 knots.

► **Try to maintain corner speed during close-in dogfights. Flying above or below corner speed degrades turn performance, giving your opponent an advantage.**

8.006 Sustained vs. Instantaneous Turn Performance

Instantaneous turn performance describes the absolute best turn performance the aircraft is capable of, generally at the lowest speed that produces maximum g-load. It only lasts for a brief moment, though, as high g-loads generate substantial drag, which quickly slows the aircraft, therefore reducing the available g-load.

► **Turning hard bleeds speed, reducing turn performance.**

Sustained turn performance refers to the aircraft's "steady state" performance where the engines' thrust reaches equilibrium with drag. Sustained turn performance will be well below the instantaneous performance, but lasts significantly longer. Theoretically, the aircraft could maintain this turn rate and radius until it runs out of fuel.

8.007 Energy Management

The key to dogfighting lies in energy management. Energy comes in two forms: kinetic energy (speed) and potential energy (altitude). As described above, speed is required to produce lift, and lift is required to increase turn performance. The engines have limited thrust, however, and increased drag further slows the aircraft. The goal of energy management, therefore, is to ensure the ability to reach corner speed at any time during a dogfight.

► **Turning too often or too hard wastes energy.**

Try thinking of energy as the money the aircraft uses to buy maneuvers. As with money, energy is usually in short supply. Careful management is required to ensure that there is enough energy available to "buy" the maneuver needed. Spending too much energy on unnecessary hard turns wastes the available energy. Like real money, once it's gone, it's gone.

Airspeed, or kinetic energy, equates to cash that can be used instantaneously to create lift and buy maneuvers. Altitude, or potential energy, equates to a savings

account that can be quickly cashed out – by diving, the aircraft quickly converts altitude into airspeed.

► **Fail to manage energy and you'll find yourself out of airspeed, altitude, and ideas!**

Managing energy requires careful attention to flight maneuvers. Don't make unnecessary high-g turns. Don't waste altitude with unnecessary dives. During a dogfight, strive to maintain corner speed. If airspeed drops too low, "unload" the aircraft. Unloading simply means relaxing the back pressure on the control stick, which reduces AOA, which then reduces g-load, which then reduces drag and therefore helps the aircraft's engines maintain the desired airspeed.

► **Unloading the aircraft by relaxing the g-load reduces drag and helps the aircraft accelerate.**

PRIMARY FLIGHT SCHOOL

Air combat accounts for very little of a pilot's total flight time. Taking off, navigating to the target, navigating back home again, and landing occupy most of a pilot's flight.

► If you can't find your way to the target, or can't find your way back home, you'll have a very short career as a fighter pilot!

9.001 Navigating with the HSI

Modern combat aircraft provide excellent steering and navigational cues on the HUD. But what happens if the HUD is damaged? The Horizontal Situation Indicator (HSI) provides an integrated backup solution. Russian and U.S. HSI's differ somewhat, but both provide the same basic information:

- A pointer to the next steer point.
- The range to the next steer point.
- The aircraft's current heading.
- U.S. HSI's include a flight path deviation needle, which shows deviation from the desired flight path.
- Russian HSI's include ILS needles within the center.
- Russian HSI's include a wide needle which points to the desired flight path.

The pointer to the next steer point indicates the direct path from the aircraft's present position to the steer point. However, the programmed course may be designed to avoid enemy troops, SAM batteries, or AAA sites. In that case, it is better to use the course deviation indicators to find the desired flight path, and then use the steer point needle to proceed to the next steer point.

9.002 Landings

Landings distinguish good pilots from mediocre pilots and are the most critical part of flying.

► The secret to all good landings is the approach.

During landings, generally fly a constant AOA until flaring just before touchdown. The AOA indexer, usually located near the HUD, provides a graphic indication of the required AOA. If the top light illuminates, the aircraft is too slow or the AOA is too high. If the bottom light illuminates, the aircraft is too fast or the AOA is too low. The middle light indicates a proper approach AOA.

► Move the stick as little and as smoothly as possible.

During landings, proper procedure "reverses" the controls. The throttle, normally used to control airspeed, is now used to control altitude. Likewise, the control stick, normally used to change altitude, is used to control airspeed. Flying the approach, first establish the appropriate AOA. Then, if the aircraft accelerates too much, pull back on the stick and increase the pitch angle. This bleeds speed and slows the aircraft. If the aircraft slows down, drop the nose a little to pick up speed. Meanwhile, if the altitude drops too fast, increase throttle. If the altitude climbs, reduce throttle.

Alternatively, some pilots live by the motto, "Aimpoint, airspeed." In other words, using the velocity vector or visual steering, point the aircraft such that it is heading for the end of the runway (the aimpoint). Next, adjust airspeed to the appropriate landing speed. By maintaining both attributes, the aircraft will follow a proper approach.

Always use the proper speed to maintain the correct AOA during final approach. The following table provides an estimation of the speed required for empty aircraft:

Aircraft (Clean)	Final Approach Speed	Touchdown Speed
Su-25	280 km/h	210 km/h
Su-27	300 km/h	250 km/h
MiG-29A	280 km/h	235 km/h
F-15	125 knots	115 knots
A-10	120 knots	110 knots

► If flaps are unavailable, increase speed by 10 knots or 15 km/h. If carrying significant fuel or stores, increase approach speed as necessary to maintain correct AOA.

Always steer to land the aircraft with the nose wheel directly on the runway centerline. As the saying goes, "The centerline is for pilots. The rest of the runway is for passengers."

9.003 Instrument Landing System (ILS)

Both Russian and U.S. aircraft use the same Instrument Landing System (ILS). The ILS uses two needles to guide the aircraft down the proper approach trajectory, called the glide path. The horizontal glideslope deviation bar shows the desired altitude. The vertical, localizer deviation bar shows the desired heading. When the needles are centered, the aircraft is flying the correct glide path. If the aircraft is off course, the needles drift outwards. Always fly toward the needles; if the localizer bar drifts to the right, turn right. If the glideslope bar drops, descend.

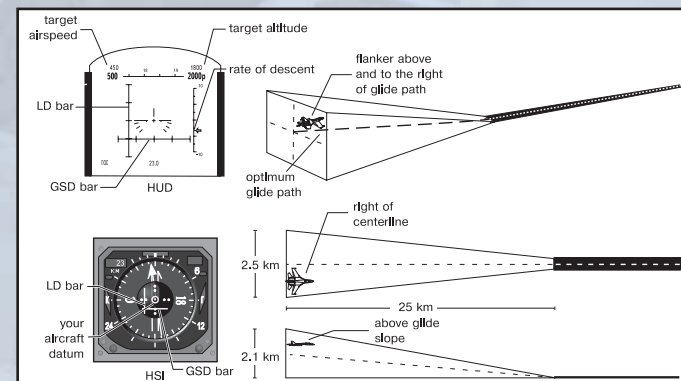

The ILS System

9.004 Crosswind Landings

Crosswind landings are a little more difficult since the wind is pushing the aircraft across the runway. Turn slightly into the wind, keeping that wing dipped. Point the aircraft slightly off the side of the runway. Right before touchdown, level the wings and turn directly onto the runway. Alternatively, apply rudder toward the wind, flying at a constant sideslip. Many pilots find the second technique easier; however, in a strong crosswind, the sideslip angle may be prohibitive.

► **Avoid crosswind landings if the crosswind speed is greater than 30 knots.**

AIR COMBAT BASICS

Strategy and Tactics Overview

Modern technology has completely revolutionized the battlefield in less than a century. Aircraft, in particular, have advanced from little more than motor-powered kites to modern combat jets in just a few decades. Defense contractors and military officials often cite the strengths of their vehicles, but rarely mention the major shortcomings in public. Consequently, many people develop an opinion that aircraft (and other battlefield platforms) are more capable than they really are.

The primary reason flight-simulator pilots get shot down is inappropriate usage of their platform. Keep in mind that surface-to-air defenses and enemy aircraft have made the same technological leaps. True, today's aircraft are significantly more powerful and resilient than their WWII counterparts; at the same time, enemy gunfire is much more accurate, powerful, and able to fire at longer ranges. In short, the battlefield is a more dangerous place than ever before.

Understanding Enemy Air Defenses

Enemy air defenses, including surface-to-air missiles and anti-aircraft artillery, are an integral part of the modern battlefield. Interlinked defense nets let defense sites across the battlefield communicate and share information. Pilots must possess a thorough knowledge of (and a strong respect for) such systems, or they'll find themselves riding a parachute with alarming frequency.

AAA

In general, Anti-Aircraft Artillery (AAA) is effective against low-flying targets and mainly serves for covering troops from enemy aircraft. Many armies have multi-barreled mobile AAA systems fitted with radar and a fire-control system that provide effective operation in any meteorological conditions. In contrast to ground forces, ship-borne artillery usually has a multipurpose character, and fighting against airborne targets is just one of their several functions.

An AAA shell consists of a warhead, an impact fuse that detonates at the moment of contact with the target, and a "time fuse," which detonates after a particular flight time. The target is generally destroyed by the fragments produced by the warhead on detonation.

Land-based systems, like the ZSU-23-4 Shilka (pronounced 'shil-ka') employ multi-barreled cannons, off-road mobility, and high rate of fire. Usually equipped with its own radar, self-propelled AAA usually has some backup aiming method, such as an IR or optical seeker.

To destroy low-flying airborne targets, combat ships use multipurpose guns that can also be used against enemy ships and coastal defense. For the most part, shipborne artillery is classed as 100 to 130mm guns (heavy caliber), 57 to 76mm guns (medium caliber), and 20 to 40mm guns (small caliber). All guns have a high degree of automation of aiming, loading, and firing. Automatic small-caliber (20-40mm) anti-aircraft guns are mainly effective against low-flying aircraft and cruise missiles. Since SAMs normally have a substantial minimum range (within which airborne targets cannot be hit) ship-borne AAA is used as a short-ranged, point-defense weapon. Firing around 1,000 rpm per barrel, such weapons create a

116 Air Combat Basics

nearly impenetrable cloud of metal between the target and the ship. Such 30mm guns have an effective range of 5,000 m; however, range is less important than rate and density of fire.

SAMs

Surface-to-air missiles (SAMs) form the backbone of the air defense network, integrating each search-and-track sensor with every unit on that network. Short-ranged, Man Portable Air Defense Systems (MANPADS) carried by infantry troops fill any gaps.

The main elements of a SAM (airframe, guidance system, fuse, warhead, and rocket motor) are similar in design and function to those of AAMs. In addition, some SAMs utilize exhaust-deflector vanes for additional maneuverability.

The flight trajectory of a SAM, as well as the composition and principle of operation of the autopilot, are governed by the guidance method employed. The autopilot on its own or with the help of ground facilities continuously calculates relative positions of the SAM and the target, and provides commands to the control surfaces. Guidance for SAMs can be classified as one of the following: command, semi-active beam-rider guidance, homing, and combined guidance.

Command Guidance

Command guidance may be compared to classic remote control. During the SAM's flight, the positions of both the target and the missile are monitored from the ground or by the missile's onboard equipment.

If a SAM is guided by the ground facilities (see the figure below), the latter are responsible for detecting the target, measuring its coordinates and those of the SAM. After processing the coordinates, the control post forms encoded guidance instructions and transmits them to the missile by radio data link, which is susceptible to jamming. After decoding by the missile's onboard equipment, the commands are sent to the autopilot. This type of command guidance is normally employed in short-range and medium-range SAM systems (such as the SA-15 and SA-8), since the guidance accuracy decreases as the range increases.

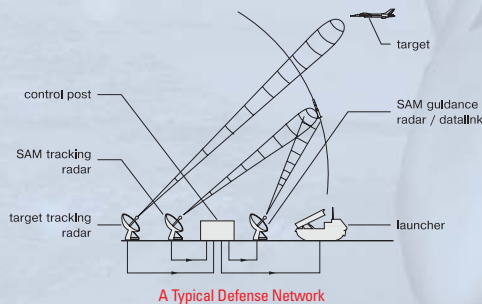

A Typical Defense Network

If the SAM itself can track the target, it measures and processes the parameters of the target's motion and sends them to the control post through radio data link. The coordinates of the SAM itself are measured by a ground-based tracking radar. Again, after comparing the coordinates of the SAM and of the target, the control

Air Combat Basics 117

post sends guidance commands to the SAM. Long-range SAM systems such as the S-300 (SA-10B Grumble) usually employ this type of command guidance in mid-course.

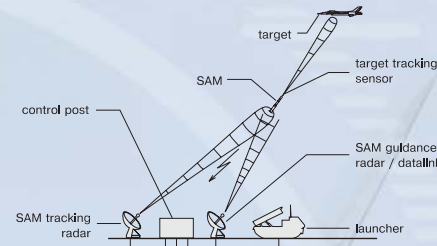

Command Guidance Sends Course Updates to the Missile

Beam-Rider Guidance

Semi-active, beam-rider guidance is somewhat similar to command guidance along the line of sight between the target and the tracking radar, except that the missile guidance system is designed to seek and follow the center of the guidance beam automatically, without specific correction instructions from the launching platform. The guidance beam is provided by a ground-based target-tracking radar, and "highlights" the direction to the target. Like command guidance systems, beam-rider SAM systems are not limited to daylight and good-weather conditions.

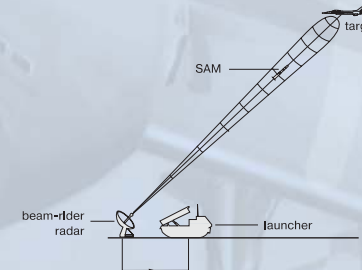

Beam-Riding Missiles Follow the Guidance Beam to the Target.

One problem with beam-rider systems, as with command ones, is that the SAM must have high maneuverability in order to intercept an evasive target. As they approach the target, beam-rider missiles often must tighten their turns continually to keep up. Using two radars, one for target tracking and a second for missile tracking and guidance, can reduce this problem somewhat by providing a more efficient lead trajectory. Beam-rider guidance is usually more accurate and faster-reacting than command guidance systems.

Homing

The most effective type of guidance against evasive targets is homing, when the missile guidance system gets information about the target and produces control commands on its own. Thus, the control post does not guide the SAM.

For active homing, the SAM illuminates the target and receives the signals reflected off the target. In the case of semi-active homing, the source of illumination (tracking radar) is located at the control post, and the SAM receives signals reflected from the target. Passive homing systems use heat or light emitted by the target to estimate the parameters of the target's motion.

In general, homing systems operate in the following way: while the SAM rests on the launcher, its seeker is locked onto the selected target, and the parameters of the target's motion are being measured. After launch the SAM seeker tracks the target, estimates the tracking error, and produces control commands independently from the ground.

Combined Guidance

As the name implies, some missiles combine guidance methods to improve performance. The Kub (Cube) SAM system (SA-6A Gainful) is an example of a system with combined guidance. This system employs radio-command guidance on the initial part of the missile trajectory and homing when closing in on the target. This provides high accuracy at long range.

SAM Engagement Envelope

Like air-to-air missiles, SAMs have specific engagement envelopes. Firing at targets within the heart of the envelope increases the likelihood of a hit. Just like air-to-air missiles, the envelope varies based on the target's range, altitude, and aspect. In the engagement diagram shown, the area defined by the numbers 1, 2, 3, 4, and 5 represent the missile's effective area. Note that this envelope shifts if the target is moving toward the launcher, in the area defined as a, b, c, d, e. In this case, the missile must be fired at longer range since the target will fly part of the way into the envelope. If the missile is fired too late (once the target has crossed the a, b, c line), it passes out of the envelope before the missile arrives.

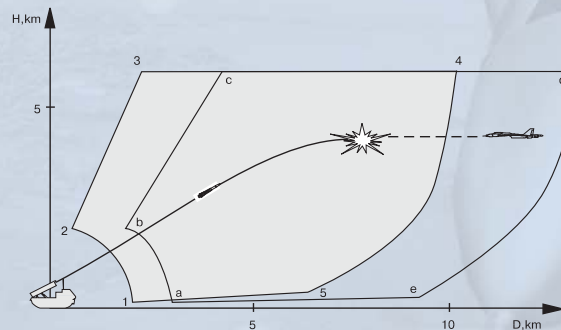

Typical SAM engagement envelope

The position of the upper and right boundaries of the envelope mainly depends on the energy capabilities of the SAM and quality of its tracking system. This boundary defines the altitude and range to the collision point providing engagement effectiveness not less than a given threshold. Since the SAM trajectory depends on target speed, altitude, and course, the position of the envelope boundary is calculated for a particular given speed of the target.

Maximum effective range of the tracking system is governed by the target's radar cross-section (or effective reflection area) and altitude, and varies substantially against different-sized targets. If for a certain target the effective range of the radar is less than that of the SAM, this will decrease the engagement envelope. SAMs are generally classified based on their range as:

- Long-range (>100 km)
- Medium-range (20 to 100 km)
- Medium-and-short range (10 to 20 km)
- Short-range (<10 km)

The position of the lower boundary of the engagement envelope depends on the radar's ability to detect and track low-flying targets and on the ability of the SAM to fly at low altitude without crashing into the ground. Besides, the proximity fuse should not mistakenly detonate near the ground by confusing the latter with a target.

Many factors, such as curvature of the ground surface, reflection of radio waves from the ground, and ground clutter, limit the possibility of detecting a low-flying target. Ground curvature limits the line-of-sight range, which affects the operation of long-range and medium-range SAMs. Indeed, if a radar antenna is located at ground level, then the radio horizon dip is about 20 m at a distance of 20 km and 150 m at a distance of 50 km. The dip of the radio horizon increases proportionally with the square of distance. This means that it will be impossible to detect a target flying at an altitude of less than 150 m while at a distance of 50 km. Lowering the radar beam will not help, as it will only create further ground-reflected interference, which further reduces range.

Furthermore, at low altitudes, it is relatively difficult for radar to discriminate between target returns and returns from local objects such as towers, moving heavy-goods vehicles, etc. Reflection intensity of local objects may vary depending on their material, size, shape, surface smoothness, etc. Consequently, returns from local objects depend on the specific operating conditions of the radar. These returns may lead to errors of measurement of angular position and range to the target, which will adversely affect the quality of guidance and may break the target lock.

To aim a SAM at a certain point, most SAM launchers are equipped with horizontal (for azimuth angles) and vertical (for elevation angles) mechanisms. Such SAM launchers are called rotary. This makes it possible to launch the SAM in the optimal direction, therewith reducing an initial vectoring error and bringing the near boundary of the SAM envelope closer. Modern SAM systems also use vertical launchers which permit simultaneous multi-direction launches.

120 Air Combat Basics

The Defense Network

Modern military forces link their early-warning and tracking radars via an interlinked network. This allows one search (or tracking) radar to share data with every other user on the same network. Consequently, the SAM launcher may not have to transmit from its own radar, instead relying on guidance from other tracking devices located elsewhere on the net. It may appear that all enemy radar sites are located several kilometers ahead of you, but you may be directly over the enemy launcher!

"Blinking," whereby different tracking radars on the network take turns tracking the target and guiding the inbound missile, is a very common practice. No one radar stays on long enough for your forces to counterattack, and the heading of the radar warning continually changes on your radar warning receiver. When caught in such a SAM trap, you must visually locate the incoming missiles, take the appropriate evasive maneuvers described later in this chapter, and get out of the trap as quickly as possible.

Countering Against Enemy Air Defenses

Successfully penetrating the enemy air defense network is difficult. The following suggestions will help you punch through, engage the target, and make it safely home again.

Don't Get Shot At

It may seem rather obvious, but the best way to avoid being hit by a missile is by preventing the enemy from ever launching one. Fighter jets are often portrayed as modern knights roaming the skies in search of a duel, but are in actuality more like cats. Skillful hunters and powerful killers, they try to slip by silent and unseen while stalking unsuspecting prey. Try to avoid enemy air defense concentrations whenever possible. If possible, flight paths should be routed toward known weak spots or other areas which have been heavily attacked.

Also, don't wander from the instructed flight path. Other aircraft and ground forces will usually be working to keep a corridor open for you. Straying out of this corridor and into enemy SAM traps is usually fatal and is a common problem for simulation pilots.

Suppression of Enemy Air Defenses

The Su-27, being rather large, isn't particularly stealthy. The pilot, therefore, must rely on tactics to mask his presence from the enemy. Perhaps the most effective way of preventing the enemy from firing is simply to shoot first. This generally means detecting the bad guys early, making a discreet approach, firing first and getting out fast. By launching a fire-and-forget anti-radar missile, such as the Kh-31p, the targeted SAM is forced to switch off its own radar to have any chance of surviving. In air-to-ground terms, strike forces should generally be accompanied by a SEAD escort: two or more aircraft equipped to engage enemy air defenses and radar sites.

Air Combat Basics 121

Low-Level Flight

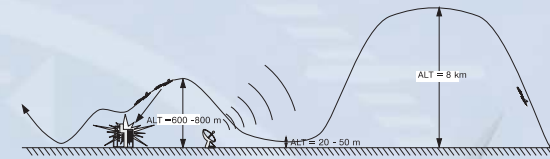

A Typical Hi-Low-Hi Ingress Profile

Such a brute-force, kick-them-in-the-teeth approach may not always be possible. There may not be sufficient aircraft available, or the enemy may have taken out friendly GCI radars. In this case, terrain masking may be the best choice. As the name implies, pilots fly extremely low (as low as 30 m above the ground in some cases), using hills, mountains, and other landscape features to remain discreet. All tactical detection systems rely on line-of-sight between the sensor and the target. Laser, radar, optical, and IR detection and tracking systems cannot penetrate hills and other such obstacles. Such nap-of-the-earth (NOE) flight is very effective, but is also very dangerous. At high speed and low altitude, the slightest mistake can result in an immediate crash. Also, AAA units will generally be placed to protect low-level ingress routes to high-value targets, further increasing the hazards of flying low. This type of tactical flying will not be effective against modern AWACS tracking, but will keep you clear of most AAA and SAM risk.

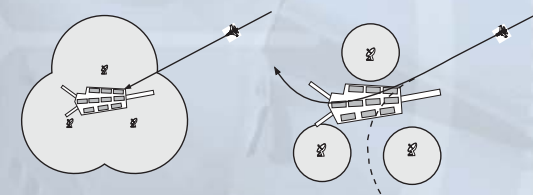

The Effects of Target Altitude on Radar Propagation. Flying High (Left) Increases Chance of Detection as Opposed to Flying Low (Right).

AAA Counter Measures

AAA systems generally cannot engage targets above 1,500 m above them. That does not necessarily mean that flying 1,501 m above sea level renders you immune to AAA. The enemy will often place AAA on hilltops or ridgelines, thus increasing their effective altitude. Generally, the best way to evade AAA is to simply climb above it. Inside its engagement envelope, however, AAA is deadly. When AAA fire suddenly erupts around you, always remember:

1. Be unpredictable. Any erratic jinking maneuvers will help disrupt the AAA's fire-control computers.
2. Don't waste energy. Each time you pull the stick to maneuver, you bleed energy and airspeed. Keep weaving, but don't slow down.
3. Don't fly in circles. Make your turns erratic and unpredictable. Whatever you do, keep flying along a general course that takes you away from the AAA. Don't fly circles above it.

122 Air Combat Basics

If you're near its effective altitude limit, you might be able to engage afterburners and quickly climb above it. This, however, poses two potential problems. First, you'll present a nice, easy target while climbing. Second, by increasing altitude you increase the likelihood of being detected by other air defenses or aircraft.

Evading Missiles

Missiles are tough opponents; they are, in general, 2–3 times faster, can pull 3–4 times more g than you, and are small and hard to track visually. Successfully evading a missile depends on many factors, such as how quickly you detect the missile and how deep you are within the weapon's launch envelope. Depending on the circumstances, you have several evasive maneuvers to choose from; choose the wrong one and the missile, quite literally, will follow you for the rest of your simulated life.

Fortunately (for the target aircraft), missiles are bound by the same laws of physics as the aircraft they chase. That is, despite having much more power available than aircraft, they bleed speed in a turn just like a fighter, and missile turn-rate and turn-radius performance depend on the missile's overall energy state. The trick to defeating missiles, therefore, is making them run out of energy before they get to you.

Launch Warnings

Launch warnings come from a variety of sources. In some circumstances, a wingman might see the launch and issue an appropriate warning over the radio. In some cases, your radar warning receiver might indicate the enemy is tracking you. In most cases, though, the best indication of an inbound missile is visual detection. When in hostile territory, constantly scan the area around you for puffs of smoke (indicating a launch) or long smoke trails that extend behind most missiles while the motor burns. Remember to scan the ground as well as the sky, as these indicators may betray a SAM launch as well as an air-to-air launch.

Keep in mind that once the missile's motor burns out, it will stop producing a smoke trail, so early detection is critical. Long-range air-to-air missiles generally climb to high altitude, then dive on the target, so be especially alert for rainbow-shaped smoke trails coming toward you!

Knowledge Is Power

Your first weapon is knowledge - knowledge about your enemy's capabilities and his position. For example, assume that a U.S.-built AMRAAM has a nominal range of 45 km at 5,000 m. You've conducted a thorough radar sweep of the area ahead of you and are certain that the only targets around are a pair of F-15s about 40 km away. Suddenly, you see the tell-tale smoke trails of inbound missiles. Since you know these missiles were fired near maximum range, you can probably out-run them. Execute a corner-speed, turn 180° away, then unload to 1 g, and accelerate directly away by diving at 30–45° at full afterburner.

Success depends primarily on how quickly the target can turn (a clean fighter may be able to pull a 9 g turn, a heavily laden jet may be limited to 5 g) and how quickly it can accelerate after that turn. If you receive warning of the launch soon enough, you stand a good chance of out-running the missile. If you're late picking up the missile or the target waits until you're deep in the launch zone before firing, this method probably won't work.

Air Combat Basics 123

Fight Missiles with Aspect

Most modern missiles fly lead as opposed to pure-pursuit paths to the target. That means each time the target changes course, the missile changes course as well. A lead-pursuit missile will attempt to hold a constant lead angle enroute to the target and appear to remain stable on your canopy relative to the horizon. A pure-pursuit missile will appear to remain pointed directly at you, but its position will drift back toward the back of your aircraft. For the most part, if the missile appears in a relatively constant position while steadily growing larger, it's successfully tracking your aircraft. If the missile appears to be rapidly moving across your canopy, it's probably going to miss you (or is tracking somebody else).

► If a missile appears stationary on the canopy while growing steadily larger, it is probably on intercept course. If it's rapidly moving across the canopy, it probably won't hit you.

Since missiles, like aircraft, need energy to maneuver and bleed speed while maneuvering, you want to make the missile maneuver as much as possible. The more you maneuver, the more work the missile must perform and the more energy it will bleed trying to adjust to your maneuvers. This forces the missile to fly a curved path to the target, bleeding speed and energy along the way.



Beaming an Inbound Missile

Begin by "beaming" the target; that is, executing a corner-speed, turn toward the missile to place it exactly 90° off your nose (to either your 3 o'clock or 9 o'clock position). Once you have the missile directly on your 3/9 line, pull just enough g-load to keep it there. The missile has a limited field of view, much like the beam of light emitted from a flashlight. If you pull a continuous 9 g turn in the middle of that "beam," the "flashlight" will fly up and punch a hole through your aircraft.

Instead, you want to fly toward the edge of the beam, known as the gimbal limit moving as fast as possible across the missile's field of view. By maneuvering to the edge of its field of view, you force it to make the largest corrective maneuvers. In the best case, you might move out of its field of view; in the worst case, you make the missile bleed as much energy as possible. Keeping the missile directly on the 3/9 line also points your hot engine exhaust away from an IR missile's seeker. Beaming may also present problems for Doppler radar systems, although remember that you're beaming the missile, not the launching platform.

Like the aforementioned flashlight beam, the missile's field of view grows wider at longer range. Consequently, at long range you'll pull minimum g. As the missile gets closer, you increase the g-load as necessary to keep it stationary on your 3/9 line. If the missile appears to move toward your nose, you're pulling too much g and basically turning inside the missile's field of view.

124 Air Combat Basics

► If the missile doesn't make constant corrective actions after you begin beaming, it probably is tracking someone else.

Be sure to release chaff and flares while maintaining this turn, especially as the missile gets closer. If you start too early, the missile will not be spoofed. Each press of the Q key releases one chaff (effective against radar-guided missiles) and two flares (effective against heat-seeking missiles) from the APP-50 dispenser in the tail boom. The system releases both since pilots rarely know exactly which type of missile is approaching. These decoys may present a more attractive target in the middle of the seeker's field of view. The missile may turn toward them, allowing you to pass out of its field of view. Modern missiles are fairly smart, though, and can often tell the difference between a quickly-decelerating bundle of chaff and your aircraft.

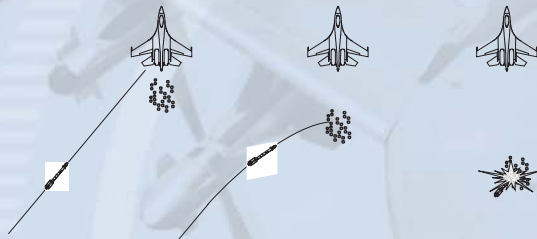

How Chaff/flares Spoof Missiles

Flying a steady flight path, followed by a high-g break turn at the last second before missile impact, probably won't work. When the missile realizes it's overshooting the target, it will detonate and (depending on the missile's blast radius) seriously damage your aircraft. Instead, make the missile work all the way and give it a generous number of chaff/flare decoys to sort through.

► Don't fly into your own decoy. Although the decoy will drift somewhat, it remains relatively stationary compared to the speed of your jet. If you continue a steady turn after releasing chaff/flares, you'll eventually fly full circle, right back around to it. Since you're trying to spoof the missile, put as much distance between you and the decoy as possible. Also, after firing a flare, disengage afterburner if practicable. This will make the flare appear an even brighter and better target than your aircraft.

Jamming

ECM Active jamming, also called Electronic Counter Measures (ECM), is designed to confuse inbound missiles by presenting them with false radar information. Jamming attempts to transmit signals in the appropriate frequency band, which overpower and mask the normal radar returns reflected by the target. If the radar source closes on the target, it will eventually reach "burn-through" range, at which point the reflected energy from the target is stronger than the false signals sent from its ECM gear.

The ECM gear doesn't actually make the missile go madly off into the wild blue yonder. Instead, it generally increases the distance between the missile and the target when the missile detonates. By sending false signals, the ECM gear may make the missile think it's closer than it actually is. By manipulating the

frequency of the false signals, it can create false Doppler shifts, further confusing the missile.

Consequently, we can see that the jamming equipment must be specifically tuned for the threat at hand. Broadcasting high power across a wide spectrum is relatively difficult; therefore, the jamming equipment is usually configured to defeat the threats most likely to appear during a given mission. Consequently, successful jamming depends on intelligence gathering equipment to ensure the ECM gear is operating in the appropriate frequency ranges. Multiple jammers should be used if a wide variety of threats are anticipated.

Jamming has one drawback: it announces its presence to everyone for miles around. Imagine someone shouting at the top of their voice during a business meeting. The loud noise prevents other attendees from communicating but also draws attention to the screamer. Likewise, jamming may block the immediate threat, but also draws attention.

The Flanker normally carries a built-in ECM pack, providing defense against airborne and ground-based radars. The status of the jammer is indicated by the AG indicator on the instrument panel. The aircraft can also carry the Sorbtsiya-S ECM system (roughly similar to the U.S.-built AN/ALQ-135 jammer), which is installed in two pods on the aircraft wingtips. It can detect and recognize illumination sources and jam that frequency. If the enemy radar shuts down, the system automatically ceases jamming.

The Whole Package

In general, no one system (maneuvering, decoys, and jamming) is sufficient to spoof an incoming missile 100% of the time. Correctly combining appropriate maneuvers with well-timed decoys in a jamming environment, though, presents a formidable obstacle to inbound missiles. The key to survival, though, is early detection of enemy missiles. The earlier you see the missile, the more time you have to defeat it.

Air-to-Air Tactics

The Su-27 was built as an air superiority fighter. Despite the addition of air-to-ground ordnance (especially on the Su-33), the air-to-air is a primary part of the Flanker's mission. The main goal of air-to-air engagements usually isn't to let the situation degrade into a dogfight. Especially for interceptor aircraft like the Flanker, the goal is to engage enemy aircraft at long range before the enemy can counter attack. Ideally, the enemy aircraft are destroyed, but merely forcing them to abort their mission is often sufficient. In military terms, this latter case is called a "mission kill."

Searching For Targets

The Su-27 carries a very powerful radar, but can only provide weapons tracking information against one target at a time. The Su-33, however, can provide weapon targeting and launch solutions for two targets simultaneously. Ideally, long-range counter-air missions should always include AWACS support. With AWACS information datalinked directly to the Flanker, enemy aircraft will be painted on the MFD even if the Flanker's radar is inactive. Keeping the Flanker's radar deactivated reduces the chances of being detected by enemy aircraft (remember, enemy aircraft can detect your radar transmissions about two times farther away than

126 Air Combat Basics

your radar can detect that aircraft). Use AWACS data (or other datalinked radar information) to trap or ambush the enemy.

If AWACS isn't available, then the aircraft assigned to the mission must conduct their own air searches. Keeping in mind the limitations of the scan cone, flight leaders should order formations that allow effective searches of wide areas. Two aircraft flying in close, finger-tip formation effectively limits both aircraft. Horizontal separation lets two aircraft search a wider area; vertical separation lets them search a taller area.

Vertical and horizontal spacing also complicates the enemy's ability to track and detect friendly aircraft. Enemy search radars on fighter aircraft also have limited scan cones. Widely spacing friendly aircraft may keep some of them outside the enemy scan cone. Further, this aircraft is free to maneuver while the enemy focuses attention on the detected aircraft. The second aircraft can maneuver around and engage the enemy from its flank or rear while the first aircraft lures the enemy fighters into the trap.

When forced to conduct your own long-range searches, keep in mind that the radar cross section (RCS) of the target determines how far away the Flanker's radar will detect it. Large bombers will generally be detected much farther away than tactical aircraft. Also, ground clutter generally helps mask targets. Consequently, lower-altitude targets usually can't be detected at longer ranges.

Maneuvers

While the goal of any interceptor is to engage with long-range missiles and escape, dogfights inevitably erupt.

► Air combat is not a chess game. Pilots do not use specific maneuvers to "counter" enemy movements. Air combat is a fluid, dynamic, constantly changing environment. Rather than thinking "he did a split-S, so I'll counter with a high yo-yo," pilots instead consider where they need to point their aircraft in order to employ their weapons. They then execute the appropriate maneuver to adjust their lift vector and bring their aircraft into a firing position.

The Break Turn

The most basic defensive maneuver is the break turn. In this case, the pilot turns toward the threat aircraft to increase aspect angle and ruin the opponent's firing solution. Generally speaking, a break turn indicates a maximum-performance turn, using all available instantaneous g.

As an attacker, if the target executes a defensive break turn, you will generally resort to the high yo-yo to prevent overshooting.

The High Yo-Yo

The high yo-yo uses a relatively quick movement out of the target's plane of motion to either slow closure rate or to reduce aspect angle to the target. The high yo-yo is performed by rolling slightly behind and above the target, extending behind the target's flight path for a moment, then rolling back toward and pulling the nose down to the target. The high yo-yo generally increases the range to the target, but decreases the aspect angle, setting up a firing opportunity. The length

Air Combat Basics 127

of time between rolling away from the target until pulling back into the target determines how "big" the yo-yo is. Generally speaking, executing a series of small yo-yo's to slowly nibble away at a large angular problem is better than executing one large maneuver.

If you have an adversary executing high yo-yo's behind you in order to gain a firing position, watch the enemy's nose closely. Your movement away from him helps solve his closure rate or aspect angle problem. Whenever his nose comes off (that is, is pointed behind your flight path), relax your turn and accelerate, thus increasing your energy status. As his nose pulls back into firing position, increase the g-load and tighten your turn. Conserve your energy when his nose is off, spend your energy as he brings his nose toward a firing position.

Aerial Gunnery

Firing a gun from a moving platform, and trying to hit another moving platform executing evasive maneuvers, is no trivial task. To begin with, the bullets take a finite amount of time to leave the barrel and travel to the target; the further away the target is, the longer each projectile takes to cover the distance. During that time of flight, the target will probably execute some form of evasive maneuver; he probably won't be in the projectile's flight path by the time it gets there. So, the shooter has to "lead" the target: predict where it will be by the time the bullets get there and then fire at that point, hoping the target flies into the projectile stream. Meanwhile, gravity tugs on the projectiles, pulling them toward the ground. The farther and slower the projectile flies, the more the bullets drop. The shooter must factor this drop into the lead calculations as well.

Meanwhile, the shooter is moving also. Since he's chasing the target, he's probably flying a curved flight path. Consequently, his tracer stream appears to "bend" away since the individual rounds continue on a straight flight path. If all goes according to plan, the shooter aims ahead of the target, fires, and watches the tracers appear to fly a curved path to intercept the target.

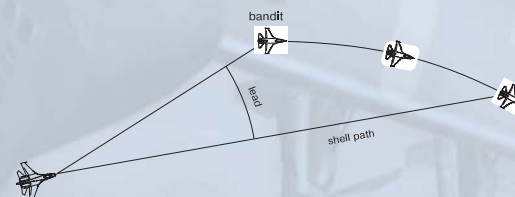

Based on this scenario, we see that the range to the target is arguably the most important aspect of aerial gunnery. The further away the target is, the longer the bullets fly. Consequently, the shooter must lead the target more and account for greater drop due to gravity. As most WWII pilots (who did not have the benefit of picking off a guided missile) discovered, don't shoot until the enemy aircraft fills the view. The closer you are, the more likely you'll hit something. Deflection shooting, or the art of appropriately leading a maneuvering target, increases in difficulty as range-to-target increases.

► **Aerial gunnery can be summarized in three steps:**

1. **Match the target's wings.**
2. **Pull lead.**
3. **Shoot.**

Tracking Shots vs. Shots of Opportunity

A tracking shot refers to a relatively slow, methodical approach to the target, achieving a stabilized firing position, and shooting the target. The shot of opportunity, on the other hand, refers to the brief moment when a target aircraft suddenly (and perhaps unpredictably) crosses your nose. You have mere moments to react, but a quick burst of gunfire is likely to score a hit if fired in time.

Whereas opportunity shots rely primarily on your reflexes, tracking shots require more finesse. In particular, you generally need to be in the same two-dimensional plane of motion as the target. This is defined by two vectors, the forward velocity (or longitudinal axis) and the lift vector (which is perpendicular to the wings). Although a good deflection shooter, especially equipped with a modern HUD and Shoot Cues, may be able to achieve the appropriate lead, maneuvering in-plane with the target aircraft greatly increases your chances of scoring a hit.

How do you maneuver into the target's plane of motion? By matching the target's wings. You can obtain a high-percentage tracking shot by maneuvering behind the target, matching the bank angle of the target's wings, then pulling sufficient lead based on the range to the target. When executed properly, the target should fly straight into the "bending" stream of your tracers.

WEAPON USAGE

Each aircraft has slightly different weapon employment procedures, primarily a function of differing Eastern and Western design philosophies. The following section describes the basic procedure for acquiring targets and firing different types of weapons. Complete details on radar operation and weapon capabilities are provided in the chapters on Sensors, HUDs, and Weapons.

After selecting the desired weapon, all delivery methods share a three-step process:

1. Detect a target.
2. Lock the target.
3. Release the weapon.

11.1 F-15C

11.101 Using AIM-120 AMRAAM

Step 1: Search for targets by using the radar in RWS or TWS modes.

Step 2: When using RWS, switch the radar to STT mode by designating a target. When using TWS mode, simply designate up to eight targets. For close-range encounters, select FLOOD mode.

Step 3: Monitor the range cues in the HUD and MFD (FLOOD mode does not provide range cues). Fire when appropriate.

► **The radar must have a target locked in STT or designated in TWS before firing an AIM-120.**

11.102 Using AIM-7 Sparrow

Step 1: Search for targets by using the radar in RWS or TWS modes.

Step 2: If using RWS mode, switch the radar to STT mode by designating a target. When using TWS mode, designate the desired target twice to switch to STT mode. For close-range encounters, select FLOOD mode.

Step 3: Monitor the range cues in the HUD and MFD (FLOOD mode does not provide range cues). Fire when appropriate.

► **The Radar must have a target locked in STT or a target within the FLOOD mode pattern before firing an AIM-7.**

11.103 Using AIM-9 Sidewinder

Step 1: Search for targets by using the radar in RWS, TWS, vertical search, boresight, or home-on-jam mode.

Step 2: When using RWS mode, switch the radar to STT mode by designating a target. When using TWS mode, designate the desired target twice to switch to STT mode. For close-range encounters, uncage the missile's seeker head and let it search for the target.

Step 3: If using radar, monitor the range cues in the HUD and MFD. If using the missile's seeker head, wait for the acquisition tone. Fire when appropriate.

► **The Radar must have a target locked in STT or acquired by the missile's seeker head before firing an AIM-9.**

11.104 Using 20 m Cannon

Step 1: Search for targets by using the radar in RWS, TWS, vertical search, boresight, home-on-jam, or gun auto-acquisition mode. (Using the gun auto-acquisition mode automatically selects the cannon as the active weapon.)

Step 2: When using RWS mode, switch the radar to STT mode by designating a target. When using TWS mode, designate the desired target twice to switch to STT mode.

Step 3: Steer the pipper over the target and fire when in range.

► **You may fire the cannon visually, without a radar-locked target.**

11.2 A-10A

The A-10A carries no onboard radar, so target detection generally occurs manually or by using built-in missile seeker systems.

11.201 Using AIM-9 Sidewinder

Step 1: Visually search for targets.

Step 2: Uncage the AIM-9's seeker head and let it search for the target.

Step 3: Wait for the acquisition tone. Fire when appropriate.

► **The missile seeker head must acquire the target before launching an AIM-9.**

11.202 Using Iron Bombs (Mk 82, Mk 84, and Mk 20 Rockeye)

Step 1: Visually search for targets.

Step 2: Steer the CCIP pipper over the target. Steady the aircraft controls, flying a stable flight path.

Step 3: Release the weapon when the pipper is over the target.

► **You must stabilize the aircraft before releasing iron bombs. Any pitch, roll, yaw, or airspeed changes will throw the bomb off course.**

11.203 Using Rockets

Step 1: Visually search for targets.

Step 2: Steer the rocket pipper over the target. Steady the aircraft controls, flying a stable flight path.

Step 3: Release the weapon when in range.

► **You must stabilize the aircraft before firing rockets. Any deviation in pitch, roll, yaw, or airspeed will send the rockets off course.**

11.204 Using Air-to-Ground Missiles (AGM-65B, AGM-65D)

Step 1: Visually search for targets.

Step 2: Steer the AGM-65 seeker over the target area and designate.

Step 3: Slew the aiming cross over a valid target and wait for seeker to lock on to target.

Step 4: Fire the missile when the target is locked.

► **The Maverick seeker head must be locked on to the target before firing the weapon.**

11.205 Using 30mm Cannon

Step 1: Visually search for targets.

Step 2: Steer the gun pipper over the target. Steady the aircraft controls, flying a stable flight path.

Step 3: Fire the cannon.

► **Maintain a stable flight path while firing the cannon. Any course changes will alter the flight path of the cannon rounds, causing them to miss the target.**

11.3 MiG-29A, MiG-29S, Su-27, and Su-33

The MiG-29, Su-27, and Su-33 share common air-to-air weapons procedures. The Su-27, being a dedicated air-to-air platform, does not employ air-to-ground weapons.

11.301 Using Air-to-Air Missiles

Step 1: For long-range scans, activate the radar and/or EOS as desired. Search for targets using the long-range BVR scan mode. The mode switches to the track-while-scan mode when a target is within tracking range. Alternatively, use the BVR mode to receive target information directly from an AWACS controller.

For short-range scans, activate the radar and/or EOS as desired. Search for targets using the close-air-combat vertical scan or helmet mounted boresight mode.

Step 2: Switch modes to the attack single-target-track mode by designating the desired target.

Alternatively, use the helmet-mounted boresight mode. If the radar and EOS are nonfunctional, missiles with IR or active radar seeker heads may use longitudinal missile-aiming mode to acquire targets.

Step 3: When the Launch Authorization symbol appears, fire the weapon. The Rejection symbol indicates the target is too close for a safe weapon launch. The Identification Friend or Foe (IFF) symbol indicates the target is friendly.

► **You must have a target locked and the Launch Authorization symbol visible in the HUD before firing an air-to-air missile.**

11.302 Using Iron Bombs (MiG-29, Su-33 only)

Step 1: Search for targets either visually or with the air-to-ground radar.

132 Weapon Usage

Step 2: If using radar, lock the target by slewing the seeker over the target and pressing the Lock button. Maneuver the aircraft to steer the CCIP pipper over the target or the diamond-shaped target designator.

Step 3: Steady the aircraft, flying a stable flight path. When the Launch Authorization symbol appears, release the weapon.

► Wait for the Launch Authorization symbol to appear in the HUD before releasing iron bombs. You must stabilize the aircraft before releasing iron bombs. Any pitch, roll, yaw, or airspeed changes will throw the bomb off course.

11.303 Using Air-to-Ground and Anti-ship Missiles (MiG-29, Su-33 only)

Step 1: Search for targets with the air-to-ground radar.

Step 2: Slew the scan cone over the target and press the Lock key. Next, slew the missile-seeker cross over the target-designator diamond. The missile's view of the target appears in the MFD. Next, fine-tune the missile crosshairs in the MFD and use the Lock key to lock the seeker on the selected target.

Step 3: When the Launch Authorization symbol appears, release the weapon. If the autotrack symbol on the left of the HUD flashes, the missile requires continuous guidance from the onboard radar. Do not break the radar lock while the Autotrack symbol flashes, or the missile will be lost.

► Wait for the Launch Authorization symbol to appear in the HUD before firing air-to-ground missiles. Do not break radar lock on the ground target as long as the Autotrack symbol is flashing.

11.304 Using Rockets (MiG-29, Su-33 only)

Step 1: Search for targets visually or with the air-to-ground radar. Locking the pod on the target helps locate it in the HUD.

Step 2: Steer the aircraft to bring the aiming reticle over the target. Steady the aircraft, flying a stable flight path.

Step 3: When the Launch Authorization symbol appears, release the weapon.

► Wait for the Launch Authorization symbol to appear in the HUD before releasing rockets. You must stabilize the aircraft before releasing rockets. Any pitch, roll, yaw, or airspeed changes will throw the rockets off course.

11.4 Su-25

11.401 Su-25 Using R-60 Air-to-Air Missiles

Step 1: Activate Air-to-Air weapons mode.

Step 2: Activate laser-ranger finder.

Step 3: Place targeting reticule over target and press the designate key.

Step 4: If the target reticule is locked to and following the target, the R-60 seeker has locked to the target.

Step 5: Launch the missile.

11.402 Using Rockets

Step 1: Activate Air-to-Surface weapons mode.

Step 2: Select Air-to-Surface rockets.

Step 3: Activate laser range finder.

Step 4: Place aircraft in shallow dive towards target.

Step 5: When aiming reticule is over target, launch rockets.

11.403 Using Bombs

Step 1: Activate Air-to-Surface weapons mode.

Step 2: Select bombs.

Step 3: Activate laser range finder.

Step 4: Place aircraft in a 30- to 60-degree dive towards target.

Step 5: When aiming reticule is over target, drop bombs.

11.404 Using Anti-Radar Missile

Step 1: Activate Air-to-Surface weapons mode.

Step 2: Select anti-radar missile.

Step 3: Activate laser range finder.

Step 4: Fly towards radar emitter.

Step 5: When aiming reticule is over target, launch missiles.

11.405 Using Guided Missiles

Step 1: Activate Air-to-Surface weapons mode.

Step 2: Select guided missile.

Step 3: Activate laser range finder.

Step 4: Fly towards target.

Step 5: Place aiming reticule over target and designate.

Step 6: Before or after missile launch, use slew keys to adjust aiming point.



Lock On Design Team

WARRANTY

Ubisoft warrants to the original purchaser of its products that the products will be free from defects in materials and workmanship for a period of ninety (90) days from the date of purchase. Ubisoft products are sold "as is," without any expressed or implied warranties of any kind, and Ubisoft is not liable for any losses or damages of any kind resulting from use of its products. Ubisoft agrees for a period of ninety (90) days to either replace defective product free of charge provided you return the defective item with dated proof of purchase to the store from which the product was originally purchased or repair or replace the defective product at its option free of charge, when accompanied with a proof of purchase and sent to our offices postage prepaid. This warranty is not applicable to normal wear and tear, and shall be void if the defect in the product is found to be as a result of abuse, unreasonable use, mistreatment, or neglect of the product.

Limitations: This warranty is in lieu of all other warranties and no other representations or claims of any nature shall be binding on, or obligate Ubisoft. Any implied warranties applicable to Ubisoft products, including warranties of merchantability and fitness for a particular purpose, are limited to the ninety (90) day period described above. In no event will Ubisoft be liable for any special, incidental, or consequential damages resulting from possession, use, or malfunction of Ubisoft products. Some states do not allow limitations as to how long an implied warranty lasts and/or exclusions or limitations of incidental or consequential damages. So the above limitations and/or exclusions of liability may not apply to you. This warranty gives you specific rights, and you may also have other rights that vary from state to state.

Notice: Ubisoft reserves the right to make improvements in its products at any time and without notice.

Refunds: Ubisoft cannot provide refunds or otherwise process returns for credit of any kind other than an identical product replacement. Any product refund request must occur at the place of purchase, as the individual retail outlets set their own refund policy. This policy covers identical product replacements only.

Product/Documentation Replacements: Please contact a Ubisoft Technical Support Representative directly before sending your product to us. In many cases, a replacement is not the best solution. Our Support Representatives will help you determine if a replacement is necessary or available. You will need to first acquire an RMA (Return Materials Authorization) number to process your return or replacement. Without an RMA number from a Support Representative, your replacement request will not be processed.

If we determine a return or replacement is necessary:

Within the 90-Day Warranty Period: Please return the product (media only) along with a copy of the original sales receipt, showing the date of purchase, a brief description of the difficulty you are experiencing including your name, address (no PO boxes) and phone number to the address below. If the product was damaged through misuse or accident (cracks, scratches), or if you do not have a dated sales receipt, then this 90-day warranty is rendered void and you will need to follow the instructions for returns after the 90-day warranty period.

After the 90-Day Warranty Period: Please return the product (media only) along with a check or money order for the amount corresponding to your product (see replacement fees below) made payable to Ubisoft, a brief description of the difficulty you are experiencing, including your name, address (no PO boxes), RMA number, and phone number to the address below.

Replacement Fees: Our most recent replacement fee schedule is available online. Please visit <http://support.ubi.com> for an updated price list.

Warranty Address and Contact Information

Phone: 919-460-9778

Hours: 9am–9pm (EST), M–F

Address: Ubisoft Support, 3200 Gateway Centre Blvd., Suite 100, Morrisville, NC 27560

Please use a traceable delivery method when sending products to Ubisoft.

To order Ubisoft products in the United States, please call toll free 888-824-7038.

TECHNICAL SUPPORT

Before contacting Ubisoft's Technical Support department, please first read through this manual and the README file (on the game CD). Also browse through our FAQ listings or search our support database at our website, <http://support.ubi.com>. Here you will find the most recently updated information since the game's release.

Also, please make sure that your computer meets the minimum system requirements, as our Support Representatives will be unable to assist customers whose computers do not meet these criteria.

Whenever you contact the Technical Support Department, please include the following information or have it available if you are calling:

- Complete product title (including version number).
- Exact error message reported (if applicable) and a brief description of the problem you're encountering.
- Operating system.
- Processor speed and manufacturer.
- Amount of RAM.
- Video card that you are using and the amount of RAM it has.
- Type of sound card you are using.
- Maker and speed of your CD-ROM or DVD drive.

Contact Us over the Internet: This is the best way to contact us. Our website is open 24 hours a day, 7 days a week, and it contains the most up-to-date Technical Support information available, including patches that can be downloaded free of charge. We update the Support pages on a daily basis, so please check here first for solutions to your problems: <http://support.ubi.com/>.

Contact Us by Email: For fastest response via email, please visit our website at: <http://support.ubi.com/>.

From this site, you will be able to enter the Ubisoft Solution Center where you can browse through our listings of Frequently Asked Questions (FAQ), search our database of known problems and solutions, or, for fastest email response, you can send a request for Personal Assistance from a Technical Support Representative. It may take up to 72 hours for us to respond to your email depending upon the volume of messages we receive.

Contact Us by Phone: You can also contact us by phone by calling 919-460-9778 (for our customers in Quebec, we provide French language support at 866-824-6515). Please note that this number is for technical assistance only. No hints or tips are given over the Technical Support line. When calling our Technical Support line, please make sure you are in front of your computer and have all of the necessary information listed above on hand. Be advised that our Technical Support Representatives are available to help you Monday–Friday from 9am–9pm EST (French language support is available from 7am–4pm EST). While we do not charge for Technical Support, normal long distance charges apply. To avoid long distance charges, or to contact a Support Representative directly after these hours, please feel free to use one of the other support avenues listed above. Email issues usually receive a response within 2 business days.

Contact Us by Standard Mail: If all else fails you can write to us at:

Ubisoft Technical Support, 3200 Gateway Centre Blvd., Suite 100, Morrisville, NC 27560

Return Policy: Please do not send any game returns directly to Ubisoft before contacting Technical Support. It is our policy that game returns must be dealt with by the retailer or online site where you purchased the product. If you have a damaged or scratched CD, please visit our FAQ listing for your game and get the latest replacement policy and pricing. We will not accept unsolicited returns/exchanges without prior approval and an RMA (Return Materials Authorization) number from a Support Representative.